

2011 Klimatizácia v ponuke Inter Cars

Ponuka náhradných dielov, príslušenstva a zariadení
pre obsluhu a opravu systémov klimatizácií vo vozidlách.

Aktuálnosť publikácie: máj 2011



Obsah

1. Kompresory klimatizácií	3-18
Spojky kompresorov a ich časti	4
Ložiská kompresorov	10
Tesnenia kompresorov	11
Regulačné ventily	17
2. Kondenzátory, výparníky, osušovač	19
3. Škrtiace trisky, ventily	21
4. Ventilátory a motorčeky	22
5. Senzory, spínače, krokové motorčeky	23
6. Vedenia, hadice	24
7. Časti na opravu vedení klimatizácií	25
8. O-ringy, montážne sady	29
9. Servisné ventily	32
10. Chemické prostriedky, oleje PAG	33
11. Plničky klimatizácie	35

Ponuka náhradných dielov a príslušenstva

Nižšie predstavujeme výrobcov, ktorých produkty sú ponúkané prostredníctvom siete pobočiek Inter Cars. Najčastejšie predávané produkty sú dostupné sklados, produkty s nižším dopytom sú realizované na individuálnu objednávku zákazníka.

V každej skupine výrobkov uvedených v tejto publikácii je uvedená informácia v tabuľke o výrobcov, ktorých tovar je dostupný v ponuke IC ako aj informácia o spôsobe ich vyhľadávania, tzn. aké katalógy sú dostupné, pomocou ktorých je možné vytypovať daný diel.



Airstal™ - hlavnou oblasťou pôsobenia firmy je repasovanie a predaj automobilových kompresorov klimatizácie. Ponuka obsahuje vyše 900 kompresorov. Ponúkané výrobky sú regenerované v súlade s najvyššími štandardmi a pri použití najmodernejších strojov. Každý kompresor je testovaný na výkon a tesnenie pomocou zariadení Thermolab Global a Inficon. S každým výrobkom je dodávaný výsledok testu a záručná karta.



BEHR HELLA SERVICE - je novou spoločnosťou joint venture, ktorá vznikla spojením dvoch firiem Behr a Hella. Bola vytvorená so zámerom spoločne pôsobiť na globálnom nezávislom trhu s dielmi na chladenie motora a klimatizácie vozidiel. Vďaka pevnému postaveniu firmy Behr aj Hella na trhu, je novovzniknutá spoločnosť už špecializovaným a popredným dodávateľom v oblasti termických systémov. Vďaka vyše 6.000 výrobkom s vysokou kvalitou ponúka Behr Hella Service bezkonkurenčné pokrytie trhu.



Delphi - firma funguje na trhu náhradných dielov od začiatku 20. storočia a dnes je jedným s piatich najväčších dodávateľov náhradných dielov vo svete. Všetky výrobky Delphi určené na trh náhradných dielov sú projektované a vytvárané podľa originálnych špecifikácií alebo ich náhrad. Delphi je tiež výrobcom komponentov a kompletných systémov klimatizácie, montovaných v takmer všetkých značkách vozidiel.



Novinka v ponuke – DENSO – je jedným z najväčších výrobcov na svete a dodávateľom dielov a komponentov pre automobilový priemysel. Dodatočne firma dodáva svoje výrobky na trh náhradných dielov, zaoberá sa tiež výrobou prenosných klím a iných elektronických zariadení. Mnohí, nielen japonskí, ale aj európski výrobcovia automobilov montujú do vozidiel systémy klimatizácie s kompresormi firmy DENSO. V ponuke firmy Inter Cars nájdete veľa týchto komponentov.



Novinka v ponuke – FOUR SEASONS EUROPE - firma pôsobí na trhu už vyše 10 rokov a je jedným z popredných dodávateľov náhradných dielov a nástrojov na opravu systémov chladenia a klimatizácie. Ponuka firmy obsahuje kompletný program komponentov pre osobné, úžitkové, nákladné, off-road a poľnohospodárske vozidlá.



Nissens – je jedným z najväčších svetových výrobcov chladičov a komponentov termických systémov. Vyrába všetko čo sa spája s výmenou tepla v osobných, úžitkových a nákladných vozidlách. V ponuke sa nachádzajú tiež komplexné riešenia a termické systémy pre priemysel, poľnohospodárstvo a vojsko. Od svojho založenia v roku 1921 Júliusom Nissenom sa firma nepretržite rozvíja ponúkajúc dnes najmodernejšie riešenia v chladení.



NRF – firma existuje od r. 1927. Je výrobcom a dodávateľom výrobkov súvisiacich s termickými systémami v automobilovom a železničnom priemysle. Pokročilá technológia dovoľuje výrobu komponentov nachádzajúcich využitie počnúc od malých osobných vozidiel až po najväčšie vozidlá a priemyselné stroje.



TEAMEC – firma bola založená v roku 1957. Od roku 1988 sa venuje továrenskej regenerácii kompresorov klimatizácie a čerpadiel Common Rail. Ponuka kompresorov klimatizácie obsahuje všetky typy, ktoré sú vo výbave zároveň osobných vozidiel, úžitkových ako aj nákladných vozidiel a autobusov. Regenerácia sa uskutočňuje podľa noriem výrobcov kompresorov, a vo výrobnom procese sú použité len komponenty najvyššej kvality a elementy renomovaných výrobcov. Každý výrobok je na konci výroby podrobený testom na tesnenie a funkčnosť na špecializovaných testovacích zariadeniach.



NOVINKA - Thermotec - špecializovaný výrobca vysoko kvalitných náhradných dielov pre chladiace systémy a systémy klimatizácie pre automobily všetkých značiek.



VALEO – je to medzinárodná skupina špecializujúca sa na projektovanie, výrobu a predaj automobilových dielov a systémov. Valeo sa nachádza vo svetovej špičke najväčších výrobcov automobilových náhradných dielov. V priebehu svojej 80 ročnej histórie Valeo uviedlo do automobilového priemyslu veľmi veľa moderných technologických riešení.



VIEROL AG – firma je dodávateľom náhradných dielov pre európske vozidlá. Široká ponuka dielov a elementov klimatizačných systémov pokrýva vyše 95% potrieb trhu.

Pod značkou VEMO sú dodávané výrobky vysokej kvality vyrobené prostredníctvom tovární vyrábajúcich svoje výrobky pre prvovýrobu vozidiel.

Kompresory klimatizácií

V ponuke máme 900 položiek kompresorov klimatizácií pre osobné, nákladné, úžitkové vozidlá, ako aj autobusy a iné vozidlá, čím dosahujeme pokrytie 90% dopytu trhu. Fabricky regenerované kompresory sú ponúkané vo forme predaja TR*. Najčastejšie dostupné referencie sú dostupné skladosť a zvyšné sú dostupné na individuálnu objednávku do 5 dní v každej pobočke Inter Cars na Slovensku.



Výrobca	Tlačený katalóg		Elektronický katalóg CD		Katalóg on-line	Tec Doc	Forma predaja TR*	Záruka (mesiace)	Príklad indexu tovaru
	Vydanie	Index IC	Vydanie	Index IC					
	2008/2009	213349001	—	—	www.airstal.com	—	✓	12	10-0015
	2009/2010	002491 011	2008/2009	002491 009	www.hella.sk	✓	—	12	8FK351 127-021
	2010	002518 027	2009	002518 028	—	✓	—	12	TSP0155013
DENSO	2009	02521 001	—	—	—	✓	—	12	447180-4510
	2008/2009	222582 001	2009	222582 002	www.teamec.be	✓	✓	24	TM8629703

* Forma predaja TR – predaj tovarov s možnosťou vrátenia starej časti s finančným zvýhodneným kúpy nového dielu pod označením „starý diel“.



UPOZORNENIE!

Pri montáži kompresora je nevyhnutné postupovať podľa odporúčania výrobcu! Vylejte z neho olej, ktorý je v ňom, nasledovne je potrebné zistiť potrebné množstvo v danom systéme vozidla. Množstvo a druh oleja PAG, ktorým bol mazaný kompresor je uvedená na štítku obalu (napr. Airstal). Údaje o druhu a množstve potrebnom pre celý systém sú uvedené v katalógoch. Polovicu tohto objemu je potrebné naliať do kompresora, a zvyšok nalejte do systému cez servisný otvor. Spreádzkovanie olejom napusteného kompresora do plného objemu oleja môže spôsobiť jeho poškodenie!

Kompresor klimatizácie Delphi V5 - Renault

AVANTIME, VELSATIS 2.0 16V Turbo 120KW / 163KM, 2.2dCi 110KW/150KM 2001-, LAGUNA II, MEGANE SCENIC 1.8 16V, 2.0 16V / Turbo 85-120KW / 116-163KM; 1.9dCi, 2.2dCi 74-88KW / 100-150KM 2001-

Nr OE: 8200021822, 8200424250

Index: TM8600139



MOC:

252 €*

s DPH: 302,4 €*

* po vrátení starého dielu



ZÁRUKA KVALITY!

Najčastejšou príčinou poškodenia nových kompresorov sú nečistoty v systéme klimatizácie. Z tohto dôvodu výrobcovia kompresorov nastavujú pravidlá ktoré sa musia splniť počas výmeny. Okrem iných to je - preplachovanie systému správnym chemickým prostriedkom (toto sa nesmie vykonať chladivom R134a cez servisný prípoj!) - výmena expanzného ventilu/škrtiacej dýzy - výmena osúšača.

Spojky kompresorov a ich časti

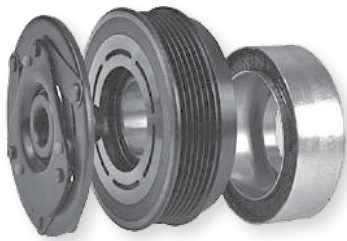



















Pre správne určenie spojky je potrebné zistiť výrobcu daného kompresora a jeho typ, napr. pomocou katalógu kompresorov klimatizácie alebo podľa označení na kompresore (vid: *tabuľka katalógov kompresorov*). Tabuľka nižšie znázorňuje najčastejšie predávané spojky, všetky dostupné v pounke. Ostatné je potrebné si vyhľadať v katalógoch nasledovných výrobcov:

Výrobca	Tlačený katalóg		Elektronický katalóg CD		Katalóg on-line	Tec Doc	Príklad indexu tovaru
	Vydanie	Index IC	Vydanie	Index IC			
	2009/2010	002491 011	2008/2009	002491 009	www.hella.sk	✓	8FA351 137-051
	2009	002518 027	2010	002518 028	—	✓	004032/2
	2009/2010	279514 001	—	—	http://www.4s-europe.com	✓	4S 48257
	2009/2010	002629 002	—	—	www.nrf.nl	✓	NRF 38420

Tabuľka kompetných spojok kompresorov				
Index Thermotec	Použitie	Typ kompresora	Číslo OE kompresora, v ktorom sa spojka môže použiť	Obrázok
KTT040001	ZEXEL 24V TM 16/15/13/08 Šr. 132mm 8pk	TM 16/15/13/08	Použitie kompresorov ZEXEL Séria TM/08/13/15/16	
KTT040002	ZEXEL 12V TM 16/15/13/08 Šr. 132mm 8pk	TM 16/15/13/08	Použitie kompresorov ZEXEL Séria TM/08/13/15/16	
KTT040003	ZEXEL 12V TM 16/15/13/08 Šr. 132mm 2A	TM 16/15/13/08	Použitie kompresorov ZEXEL Séria TM/08/13/15/16	
KTT040004	ZEXEL 24V TM 16/15/13/08 Šr. 132mm 2A	TM 16/15/13/08	Použitie kompresorov ZEXEL Séria TM/08/13/15/16	
KTT040005	SANDEN PXE16 VW Golf V, Caddy III/A3 04-Šr. 110mm 6pk"	PXE16	1K0820803G, 1K0820803M, 1K0820803Q, 1K0820803S	
KTT040006	ZEXEL DCW17 Šr. 123mm 4pk	DCW17	8D0260805D, 8D0260805F, 8D0260805M, 506031-0781, 506031-0781	
KTT040007	DENSO W210/W202/Sprinter/Vito 7SB16C Šr. 125mm 6pk	7SB16C	A0002303911, 0002303911, 0002307011, 0002300911, 0002340911, 0002342411, 0002343111, 0002342911, 447100-6820, 447170-5730	
KTT040008	SANDEN TRS105 SAAB 9-3 Šr. 100mm 6pk	TRS105	4635892	
KTT040009	SANDEN 24V SD7H15 Šr. 132mm, 2A	SD7H15	Použitie kompresorov SANDEN Séria SD7H15	
KTT040010	FORD FS/FX Šr. 130mm 6pk	FS/FX	1018497, 1035431, 6997607, 7058036, 94BW19D629AC, 94BW19D629AD, BW19D629AE, 96BW19D629BA, F3DH19D649CA, 157H19D629EA	

KTT040011	DENSO VW T5		7H0820803E, 7H0820805C	
KTT040012	SANDEN Honda CIVIC 1997-2001 TRS090 Šr. 112mm 4pk	TRS090	38810-P2A-006, 38810-P06-A04	
KTT040013	DENSO Chrysler Voyager Šr. 122mm 6pk		4677156, 447100-6620, 4677144AB	
KTT040014	HARRISON V5 Opel Omega B Šr. 128mm 6pk	HARRISON V5	1135106, 1135307, 1854014, 1854043, 1854050, 1854145, 24432574, 90509595	
KTT040015	HARRISON V5 Opel Vectra B Šr. 124mm 6pk	HARRISON V5	1135240, 1135292, 1135302, 1854067, 1854071, 1854079, 1854091, 1854106, 1854142, 1854144	
KTT040016	SANDEN SD7V16 A3/TT/ Golf 4/Sharan/Octavia/Leon/Toledo/Alhambra/Skoda 6pk	SD7V16	1J0820803A, 1J0820805, 1J0820803F, 1J0820803K, 7M0820803R, 7M3820803	
KTT040017	SANDEN TRS110R CRV 7pk	TRS110R	38810PNB006	
KTT040018	DENSO Audi/Skoda/VW A6/PASSAT Šr. 126mm 6pk	7SBU16C	447100-7920, 447170-6340, 447220-8170, 447300-4970, 480260805B, 483260805, 4D0260805B, 4D0260808	
KTT040019	DENSO Toyota Šr. 130mm 7pk	10S17	447220-4270, 447220-4273, 88320-06080	
KTT040020	DENSO Audi/Skoda/VW A4/A6/PASSAT Šr. 126mm 4pk	7SBU16C	447100-9270, 447170-6350, 447300-6040, 8D0260805B, 8D0260805J, 8D0260808	
KTT040021	DENSO Audi/Mercedes Šr. 105mm 8pk		447260-0850, 447190-4843	



















Tabuľka kompletných spojok kompresorov

KTT040022	DENSO Audi Šr. 115mm 7pk		447180-4477		KTT040031	DENSO Toyota Avenis Diesel Šr. 105mm 5pk	5SE/6SE	447180-8640, 8831005110	
KTT040023	DENSO Audi/Mercedes Šr. 115mm 6pk		A0002306411, A0002306511, A0002308811, A0002309511, A0012300811, A0012301211, A0012308111		KTT040032	DENSO Audi A6 Šr. 115mm 6pk		4F0260805Q, 4F0260805M	
KTT040024	DENSO Audi/Mercedes Šr. 115mm 6pk		55 70 3721, 68 54 093, 68 54 104		KTT040033	DENSO Audi A4 /Seat/ Skoda/VW Šr. 114 mm 4pk	7SEU16C	447170-9090, 447180-5350, 447180-5370, 447220-8400, 447220-8403, 4B0260805M, 8E0260805AB, 8E0260805M	
KTT040025	DENSO Audi A6 Šr. 110mm 4pk	6SEU12C	4B0260805J, 8E0260805C		KTT040034	DENSO Audi Šr. 100 mm 6pk	6SE/7SE	447190-6680, 8E0260805AG, 8E0260805AT, 8E0260805BA, 8E0260805BF, 8E0260805BJ, 8E0260805BP, 8E0260805CB	
KTT040026	DENSO Audi/Seat/Skoda/VW Šr. 110 mm 4pk		64526925721, 64526921649, 64506901781, 4471807550, 4471807555		KTT040035	DENSO Mercedes A-klasa Šr. 100 mm 6pk		12 309 011, 001 230 35 11, 002 230 13 11	
KTT040027	DENSO Audi/Mercedes Šr. 116 mm 8pk				KTT040036	DENSO Mercedes W211 Šr. 115 mm 6pk		4471805650, 4471908341, 0002306511, 0002308011, A0002308111, A0002308511, A0002308811, 0002309011, A0012301411, A0012301711	
KTT040028	DENSO Fiat/Opel/GM Šr 110 mm 5pk		447190-5040, 55701200, 6854091, 6854102, 93190812		KTT040037	DENSO BMW E90/E60 Šr. 100 mm 4pk		64526917859, 64526983098, 64 52 6 917 859, 447180-6764,	
KTT040029	DENSO Toyota Yaris Šr. 120 mm 6pk	5SE	88310-0D070, 88320-52010		KTT040038	DENSO Audi/Mercedes Šr. 110 mm 6pk	6SE/7SE	8Z0260805A, 6Q0820803D, 6Q0820803G, 6Q0820803H, 6Q0820803J, 6Q0820803K, 6Q0820803L, 8Q0820803H, 8Q0820803R, 8Z0260808A	
KTT040030	DENSO Toyota Avenis Benzyna Šr. 125 mm 6pk	5SE/6SE	447260-2272, 8831005080		KTT040039	DENSO Audi Šr. 125 mm 6pk	7SE/6SE	447180-7722, 4F0260805AB, 4F0260805AF, 4F0260805R, 4F0260805K	









Tabuľka kompletných spojok kompresorov - obrázky s indexmi



















				
KTT040001	KTT040002	KTT040003	KTT040004	KTT040005
				
KTT040006	KTT040007	KTT040008	KTT040009	KTT040010
				
KTT040011	KTT040012	KTT040013	KTT040014	KTT040015
				
KTT040016	KTT040017	KTT040018	KTT040019	KTT040020



























Tabuľka kompletných spojok kompresorov - obrázky s indexmi









				
KTT040021	KTT040022	KTT040023	KTT040024	KTT040025
				
KTT040026	KTT040027	KTT040028	KTT040029	KTT040030
				
KTT040031	KTT040032	KTT040033	KTT040034	KTT040035
				
KTT040036	KTT040037	KTT040038	KTT040039	













Časti spojok kompresorov - kotúč spojky

Index	Zámena	Typ	Použitie	Číslo OE kompresora, v ktorom sa kotúč môže použiť	Obrázok
KTT020001	NRF 38473 - kompletná	DENSO 6SEU/7SEU	Kotúč DENSO 6SEU/7SEU - pre kompletnosť potrebná KTT020003	Použitie kompresorov DENSO Séria 5SEU\6SEU\7SEU (vysoká)	
KTT020002		DENSO 6SEU/7SEU	Kotúč DENSO 6SEU/7SEU - pre kompletnosť potrebná KTT020004	Použitie kompresorov DENSO Séria 5SEU\6SEU\7SEU (nízka)	
KTT020003	NRF 38473 - kompletná	DENSO 6SEU/7SEU	DENSO - pre kompletnosť potrebná KTT020001	Použitie kompresorov DENSO Séria 5SEU\6SEU\7SEU (Vysoká)	
KTT020004		DENSO 6SEU/7SEU	DENSO - pre kompletnosť potrebná KTT020002	Použitie kompresorov DENSO Séria 5SEU\6SEU\7SEU (nízka)	
KTT020005	NRF 38474	DENSO 6SEU/7SEU /SSL12/5SE12	DENSO 6SEU/7SEU/SSL/SE/12	AUDI/SEAT/SKODA/VW/BMW/MERCEDES	
KTT020006		DENSO 6SEU/7SEU /SSL12/5SE12	Tlmič gumovej remenice DENSO	Použitie kompresorov DENSO Séria 5SEU\6SEU\7SEU	
KTT020007		DENSO 6SEU/5SL12/5SE12	TOYOTA YARIS / BMW E60 Kompresor DENSO 5SE09C/7SEU17C	DENSO 5SE09C/7SEU17C	
KTT020008		DENSO 5SEU/7SEU	A20-5206 Tlmič gumovej remenice KOMPRESOR - DENSO 5SEU/7SEU TOYOTA/BMW	Použitie kompresorov DENSO Séria 5SEU\6SEU\7SEU	
KTT020009		ZEXEL DCS17E	AUDI/SEAT/SKODA/VW KOMPRESOR - ZEXEL DCS17E	1K0820803H, 1K0820803N	

Časti spojok kompresorov - kotúč spojky					
Index	Zámena	Typ	Použitie	Číslo OE kompresora, v ktorom sa kotúč môže použiť	Obrázok
KTT020010		DENSO 75EU16C T5	OZUBNICA VW - T5 KOMPRESOR - DENSO 75EU16C	7H0820803E, 7H0820805C	
KTT020011		DENSO 10PA /11/13/15/17/20/75B/75-BU/6CA17	DENSO	Použitie kompresorov DENSO Séria 10PA15/10PA17/10PA20/75B16/75BE16	
KTT020012		FORD FS/FX	FORD FS/FX	Použitie kompresorov FORD FS/FX	
KTT020013		FORD FS/FX	FORD FS/FX	Použitie kompresorov FORD FS/FX	
KTT020014		SANDEN SD7H15/V16 SD6V12	SANDEN	Použitie kompresorov SANDEN Séria SD7H15/SD7V16/SD6V12	
KTT020015		SANDEN SD7H15/V16/SD6V12	SANDEN	Použitie kompresorov SANDEN Séria SD7H15/SD7V16/SD6V12	
KTT020016		SANDEN SD7H15/V16/SD6V12	SANDEN	Použitie kompresorov SANDEN Séria SD7H15/SD7V16/SD6V12	
KTT020017		PANASONIC MATSUSHITA H12A1/A2	MAZDA - KOTUČ SPOJKY KOMPRESORA - ZEXEL DKS 220	MAZDA - KOTUČ SPOJKY KOMPRESORA - ZEXEL DKS 220	
KTT020018		PANASONIC MATSUSHITA H12A1/A2	NISSAN KOTUČ SPOJKY KOMPRESORA - CALSONIC CR14 Rozmery - SR.ZEW. - 109,5mm	NISSAN Kotúč SPRZEGĽA KOMPRESOR - CALSONIC CR14 Rozmery - SR.ZEW. - 109,5mm	
KTT020019		PANASONIC MATSUSHITA H12A1/A2	MAZDA - KOTUČ SPOJKY KOMPRESORA - PANASONIC Rozmery SR.ZEW.109,5mm	MAZDA - KOTUČ SPOJKY KOMPRESORA - PANASONIC rozmery priemeru ZEW.109,5mm	
KTT020020		FORD FS/FX	FORD MONDEO II, III Rozmery - SR.ZEW. - 122mm	1018497, 1035431, 6997607, 7058036, 94BW19D629AC, 94BW19D629AD, 94BW19D629AE, 96BW19D629BA, F3DH19D649CA, 157H19D629EA,	
KTT020021		ZEXEL TM 16/15/13/11/08	ZEXEL	Použitie kompresorov ZEXEL Séria TM 08/11/13/15/16/18/21	
KTT020022		SANDEN SD7V16	KOTUČ SPOJKY KOMPRESORA - CH201- SANDEN SD7V16 AUDI/SEAT/SKODA/VW	1J0820803A, 1J0820805, 1J0820803F, 1J0820803K, 1J0820803F, 1J0820803K, 7M0820803R, 7M3820803, 7M3820803A, 1J0820803A, 1J0820805, 1J0820803F, 1J0820803K, 7M0820803R, 7M3820803, 7M3820803A, 1J0820803A, 1J0820805, 1J0820803F, 1J0820803K, 7M0820803R, 7M3820803, 7M3820803A	
KTT020023		SANDEN SD7H15 24V	TRSA090 HONDA/INNE SANDEN TRS090	38810-P06-A04, 38810-P2A-A04	
KTT020024		SANDEN PXV16	Opel/Saab/Landrover KOMPRESOR - SANDEN PXV16	24411270, 6854007, 93176866, 6854003, 9225560, 93176868, 1854113, 6854025, 9132925, 93176856, 13140505, 24411249, 6854005, 6854019, 93176867, 24411280, 24411249	
KTT020025		DELPHI CVCC	OPEL ASTRA G/H KOMPRESOR - DELPHI CVCC	1854119, 9132918, 93176876, 1854111, 6854024, 9165714, 93176855, 1854146, 24427685, 93176875, 6854013, 93176877, 91774395, 1854087, 1854101, 93176853, 1854092, 1854102, 90559855, 9174396, 9174397, 1854088, 1854103, 90559889, 93176857, 1854123, 13124750, 6854059, 93176127	
KTT020026		DENSO 6SEU/7SEU	DENSO	Použitie kompresorov DENSO TOYOTA 2008>	
KTT020027		SANDEN SD6V12		1854107, 24422013, 24462196, 9132922, 1854147, 24421642, 6854048, 93176916, 1854086, 1854138, 90559843	

Časti spojok kompresorov - kotúč spojky - obrázky a indexy				
				
KTT020001	KTT020002	KTT020003	KTT020004	KTT020005
				
KTT020006	KTT020007	KTT020008	KTT020009	KTT020010
				
KTT020011	KTT020012	KTT020013	KTT020014	KTT020015
				
KTT020016	KTT020017	KTT020018	KTT020019	KTT020020
				
KTT020021	KTT020022	KTT020023	KTT020024	KTT020025
				
KTT020026	KTT020027			

Cievky spojok (elektromagnety)					
Index	Zámena	Typ kompresora	Použitie	Číslo OE kompresora klimatizácie v ktorom možno použiť cievku	Obrázok
KTT030001	NRF 38420	DELPHI-CVCC	Opel Astra G Benzyna	1854119, 9132918, 93176876, 1854111, 6854024, 9165714, 93176855, 1854146, 6854013, 93176877, 1854087, 1854101, 93176853, 1854092, 1854102, 90559855, 1854088, 9174397, 1854103, 90559889, 1854123, 24432392, 93176854, 13124750, 6854059, 93176127	
KTT030002		SANDEN PXV16	OPEL AGILA/COMBO/CORSA C/MERIVA/TIGRA B/ SANDEN SD6V10 model 1512/SANDEN SD6V12 model 1447	24461719, 6854020, 6854032, 13106850, 6854055, 6854081	
KTT030003		SANDEN SD6C12/SD7C16	vonk.priemer 95,8 mm , vonk. priemer - 61 mm šírka 27,5mm	CITROEN PEUGEOT SD6C12	
KTT030004	NRF 38470	SANDEN SD7V16	ELEKTROMAGNES 12V KOMPRESOR - SANDEN SD7V16	1J0820803A, 1J0820805, 1J0820803F, 1J0820803K, 7M0820803R, 7M3820803, 7M3820803A, 7D0820805C, 7D0820805G, 7D0820805H, 7H0820803C	
KTT030005	NRF 38470	SANDEN SD7V16		7M0820803D, 7M0820803P, 7D0820805B, 7D0820805A, 357820803R, 7M0820803M, 7M0820803Q, 7D0820805E, 7D0820805Q, 1H0820803D	
KTT030006	45 4700060	SANDEN SD7H15 24V	SANDEN SD7H15 ZASILANIE - 24V	5010237488, 5010412962, 5001845312, 5010240457, 5010483009, 5001845318, 5010412961, 5010483099, 5001858486, 81619066012, 1387322, 1251063, 1264800, 1444295, 3962650, 8142555, 8113628, 8191892, 11104251, 8150135, 11007314, 11058974, 11007857, 11104512, 1303484, 1376998, 1412263, 1376999, 1412264, Použitie Kompresory SANDEN SD7H15	
KTT030007	NRF 38475	SANDEN SD6V12	Opel Astra G Diesel	9167048, 1854009, 1854073, 1854085, 1854100, 1854143, 6854021, 1854107, 24422013, 24462196, 9132922, 1854147, 24421642, 6854048, 93176916, 1854086, 1854138, 8971863970, 90559843, 6854020	
KTT030008		HSSY HS15/16/17/18	Vonk. priemer 101mm . 66mm šírka 35,5mm priemer. II - 63,8mm HYUNDAI	FS10 HS15 HS18	

Cievky spojok (elektromagnety)					
KTT030009		SANDEN PXV16 vonk. priemer-95,8mm vonk.priemer-61,0mm šírka-27,5mm	Opel Vectra, Saab 9-3/9-5	24411270, 6854007, 93176866, 6854003, 9225560, 93176868, 13140505, 24411249, 6854005, 6854019, 93176867, 13171593, 93187228, 24411280, 24411249	
KTT030010	45 48257	Harrison V5 Delphi	Vectra B, Omega B-C Benzyna	1135025, 1135295, 1135323, 1854032, 1854094, 1854105, 1854141, 9196953, 1131909, 1135312, 1135349, 1854008, 1854031, 1854108, 1135106, 1135307, 1854014, 1854043, 1854050, 1854145, 24432574, 90509595, 1135240, 1135292, 1135302, 1854067, 1854071, 1854079, 1854091, 1854106, 1854142, 1854144	
KTT030011		FORD - FS/FX	Vonk.priemer 63,5 vnút. 95mm	FORD FS10	
KTT030012		FORD - FS/FX	Vonk.priemer 66mm vnút. 101mm	FORD FS10	
KTT030013		FORD - FS/FX	Vonk.priemer 115mm	FORD FS10, 1018497, 1035431, 6997607, 7058036, 94BW19D629AC, 94BW19D629AD, 94BW19D629AE, 96BW19D629BA, F3DH19D649CA, 157H19D629EA	
KTT030014		FORD SCROLL	Focus / Mondeo elektromagnet s termikom	1084732, RXS7H19D629EA, XS7H19D629EA, YS7H19D629BA, 157H19D629CA, 157H19D629CB, 157H19D629CC, 1064354, 1066927, 1113006, 1123560, 467H19D629AA, DE9416450, RXS4H19D629AA, RXS4H19D629AC, XS4H19D629AA, XS4H19D629AA, XR81188, XR89202, XR820839, XR82897, XR89201	
KTT030015		SANDEN - TRS090	Honda Civic	38810-P2A-006, 38810-P06-A04	
KTT030016		DENSO Séria PA15/17/20 Séria 7SB/7SBU		Použitie Kompresory DENSO 10PA15/10PA17/10PA20/7SBU16C/7SBU16	
KTT030017		Séria PA15/17/20 Séria 7SB/7SBU"		Použitie Kompresorov DENSO ZASILANIE 24V	
KTT030018	45 4700073	ZEXEL 24V Séria TM 16/15/13/11/08	ZEXEL ZASILANIE 24V	Použitie Kompresorov ZEXEL ZASILANIE 24V	
KTT030019	45 4700070	ZEXEL 12V Séria TM 16/15/13/11/08	ZEXEL ZASILANIE 12V	Použitie Kompresorov ZEXEL ZASILANIE 12V	
KTT030020		HSSY HS15/16/17	Hyundai Trajet/Xg/Santa Fe Vonk.priemer. - 97,9mm vnútorný. 62,8mm šírka. 35,5mm priemer. II 63,8mm	HS18	

Cievky spojok (elektromagnety) - obrázky a indexy				
				
KTT030001	KTT030002	KTT030003	KTT030004	KTT030005
				
KTT030006	KTT030007	KTT030008	KTT030009	KTT030010
				
KTT030011	KTT030012	KTT030013	KTT030014	KTT030015
				
KTT030016	KTT030017	KTT030018	KTT030019	KTT030020

Ložiská spojok klimatizácie

V oblasti ložísk kompresorov klimatizácie ponúkame ložiská značiek **OPTIMAL, KOYO, NSK, NACHI** a **4Seasons**.
 Prefix indexu označuje jeho výrobcu, rozšírenie indexu jeho použitie u daného výrobcu:

OPT0-K355020 A - Výrobca **Optimal**

OPT0-K355020 NSK - Výrobca **NSK**

OPT0-K355020 Koyo - Výrobca **KOYO**

OPT0-K406624 NACHI - Výrobca **NACHI**

OPT0-K 40 57 24/20
 Ložisko kompresoru klimat. ϕd ϕD C B

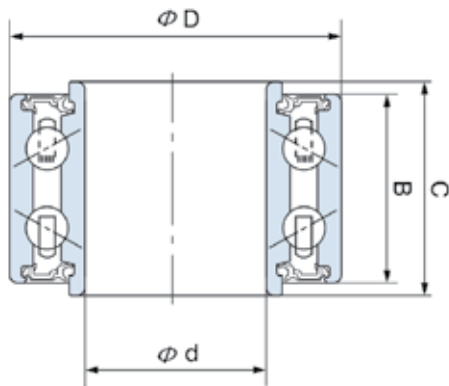

Rozmer dxDxB/C	Index Optimal	Index 4Seasons
10x26x16		4S 2500013
12x28x16	OPT0-K122816 NSK	4S 2500015
12x28x8		4S 2500014
30x46x16/18	OPT0-K304616/18 A	
30x47x12	OPT0-K304712 A	
30x47x18	OPT0-K304718 NSK	4S 2500006
30x47x18	OPT0-K304718 A	4S 25219
30x47x20	OPT0-K304720 A	4S 2500024
30x47x21/18	OPT0-K304721/18 A	
30x47x22	OPT0-K304722 A	4S 2500018
30x50x20	OPT0-K305020 A	
30x52x12		4S 2500027
30x52x20	OPT0-K305220 A	4S 2500026
30x52x22	OPT0-K305222 A	4S 25211
30x52x22	OPT0-K305222 NSK	
30x55x23	OPT0-K305523 A	4S 25204
30x55x23	OPT0-K305523 NSK	
30x62x16		4S 25208
30x62x16/24		4S 25207
30x62x27	OPT0-K306227 A	4S 25205
32x47x18	OPT0-K324718 A	
32x52x20/18	OPT0-K325220/18 A	
32x55x23	OPT0-K325523 A	4S 2500011
32x55x23	OPT0-K325523 NSK	
35x47x12		4S 2500010
35x50x20	OPT0-K355020 A	4S 2500003
35x50x20	OPT0-K355020 NSK	
35x50x20	OPT0-K355020 Koyo	
35x52x12	OPT0-K355212 A	4S 2500012
35x52x20	OPT0-K355220 A	4S 2500008

Rozmer dxDxB/C	Index Optimal	Index 4Seasons
35x52x20	OPT0-K355220 NSK	
35x52x22	OPT0-K355222 A	4S 2500005
35x52x22	OPT0-K355222 NSK	
35x52x23	OPT0-K355223 A	
35x55x20	OPT0-K355520 A	4S 25212
35x55x20	OPT0-K355520 Koyo	
35x55x20	OPT0-K355520 NSK	
35x62x21	OPT0-K356221 A	
35x62x21	OPT0-K356224 A	
35x62x24	OPT0-K356224 NSK	4S 2500009
35x62x28	OPT0-K356228 A	4S 2500023
38x54x17	OPT0-K385417 A	4S 25220
38x54x17	OPT0-K385417 NSK	
38x62x24	OPT0-K386224 A	
40x55x24	OPT0-K405524 A	4S 2500007
40x57x20/24	OPT0-K405720/24 A	
40x57x20/24	OPT0-K405720/24 NACHI	
40x57x24	OPT0-K405724 A	4S 25218
40x57x24/20	OPT0-K405724/20 NACHI	4S 25216
40x57x24/20	OPT0-K405724/20 A	
40x57x24/20	OPT0-K405724/20 NSK	
40x62x20,625	OPT0-K406220,6 NSK	
40x62x20,6	OPT0-K406220,6 A	4S 25203
40x62x20,6/24	OPT0-K406220,6/24 A	4S 25210
40x62x20,6/24		4S 25210
40x62x24	OPT0-K406224 A	4S 25217
40x62x24	OPT0-K406224 A	4S 25224
40x62x24	OPT0-K406224 NSK	
40x62x24	OPT0-K406224 Koyo	
40x62x24/20,6	OPT0-K406224/20,6 A	
40x66x24	OPT0-K406624 NACHI	
40x66x24	OPT0-K406624 A	
40x66x24	OPT0-K406624 NSK	4S 2500022
40x68x30	OPT0-K406830 A	4S 2500025
45x68x20	OPT0-K456820 A	
45x75x32	OPT0-K457532 A	

Tesnenia kompresorov

Ponuka tesnení kompresorov zahŕňa hlavné tesnenia ako aj sady tesnení tela. V tabuľke sú okrem týchto častí zobrazené aj dodatočné ložiská podľa jednotlivých modelov spojok. Diely z tej skupiny produktov je taktiež možné nájsť v katalógoch nižšie uvedených výrobcov:



Výrobca	Tlačný katalóg		Elektronický katalóg CD		Katalóg on-line	Tec Doc	Príklad indexu tovaru
	Vydanie	Index IC	Vydanie	Index IC			
	2009 / 2010	002491 011	2008/2009	002491 009	www.hella.sk	✓	9GR351 179-821
	2009 / 2010	279514 001	—	—	http://www.4s-europe.com	—	4S 24507
	2009 / 2010	002629 002	—	—	www.nrf.nl	✓	NRF 38253











Tabuľka tesnení kompresorov

Výrobca	Ložisko	Index ložiska	Hlavné tesnenie	Zámena hlavného tesnenia	Tesnenie tela	Zámena tesnenia tela
Behr Wingcell	30x55x23	OPTO-K305523	KTTO50020	-	KTTO50093	-
Bosch Axial	30x55x23	OPTO-K305523	-	-	KTTO50168	-
Calsonic CR14	35x55x20	OPTO-K355520	KTTO50065	4S 2400080	KTTO50169	-
Calsonic CWV	40x62x24	OPTO-K406224	KTTO50008, KTTO50082	NRF 38258, NRF 38465	KTTO50135	-
Calsonic DKV14D	35x55x20	OPTO-K355520	KTTO50026	-	KTTO50136	-
Calsonic V5-15	40x62x20,6	OPTO-K406220,6 A	KTTO50006	NRF 38253	KTTO50137	NRF 38302
Chrysler 6C17	40x62x20,6/24	OPTO-K406220,6/24 A	KTTO50008	NRF 38258	KTTO50094	-
Chrysler A590/C171	40x62x20,6/24	OPTO-K406220,6/24 A	KTTO50007	NRF 38257	KTTO50095	-
Chrysler RV2	30x62x27	OPTO-K306227	KTTO50002	-	KTTO50096	-
Daewoo V5	40x62x20,6	OPTO-K406220,6 A	KTTO50065	4S 2400080	KTTO50137	NRF 38302
Delphi CVC125/CVC135/135E	35x50x20	OPTO-K355020	KTTO50083	NRF 38466	KTTO50131, KTTO50151	NRF 38316
Delphi CVC165/CVC185	35x52x22	OPTO-K355222	KTTO50065	4S 2400080	-	-
Denso 55E09C	35x52x12	OPTO-K355212	KTTO50082	NRF 38465	KTTO50153	-
Denso 55E12C	35x52x12	OPTO-K355212	KTTO50082	NRF 38465	KTTO50154	-
Denso 6CA17C	35x52x22	OPTO-K355222	KTTO50013	NRF 38251	KTTO50045	-
Denso 6E171	40x62x20,6/24	OPTO-K406220,6/24 A	KTTO50007	NRF 38257	KTTO50120	-
Denso 6P127	40x62x20,6/24	OPTO-K406220,6/24 A	KTTO50007	NRF 38257	KTTO50027, KTTO50122	-
Denso 6P134	40x62x20,6/24	OPTO-K406220,6/24 A	KTTO50007	NRF 38257	KTTO50121	-
Denso 6P148	40x62x20,6/24	OPTO-K406220,6/24 A	KTTO50007	NRF 38257	KTTO50027, KTTO50122	-
Denso 65EU12	35x52x22	OPTO-K355222	KTTO50082	NRF 38465	KTTO50040	-
Denso 65EU16	35x52x12	OPTO-K355212	KTTO50082	NRF 38465	KTTO50041	-
Denso 75B16	35x52x22	OPTO-K355222	KTTO50013	NRF 38251	KTTO50133	NRF 38317
Denso 75BU16	35x52x22	OPTO-K355222	KTTO50066	NRF 38321	KTTO50039	-
Denso 75E16	35x52x20	OPTO-K355220	KTTO50082	NRF 38465	-	-
Denso 75E16 (Mercedes – nesk.)	35x52x12	OPTO-K355212	KTTO50082	NRF 38465	-	-
Denso 75EU16	35x52x22	OPTO-K355222	KTTO50082	NRF 38465	KTTO50039	-
Denso 10P08	38x54x17	OPTO-K385417	KTTO50007, KTTO50008	NRF 38257, NRF 38258	KTTO50117	NRF 38303
Denso 10P13/10P15	40x62x24	OPTO-K406224	KTTO50007, KTTO50008	NRF 38257, NRF 38258	KTTO50118	NRF 38304
Denso 10P17	40x62x24	OPTO-K406224	KTTO50007	NRF 38257	KTTO50119	NRF 38305
Denso 10P17C (Mercedes)	40x57x20/24	OPTO-K405720/24	KTTO50007	NRF 38257	KTTO50119	NRF 38305
Denso 10PA15/10PA17	30x52x22	OPTO-K305222	KTTO50007, KTTO50061	NRF 38257, NRF 38255	KTTO50162	-
Denso 10PA15C (Mercedes)	35x52x22	OPTO-K355222	KTTO50007, KTTO50061	NRF 38257, NRF 38255	KTTO50163	-
Denso 10PA15VC/10PA17VC	30x52x22	OPTO-K305222	KTTO50061	NRF 38255	-	-
Denso 10PA17	30x52x22	OPTO-K305222	KTTO50179	-	KTTO50162	-
Denso 10PA17C (BMW)	30x52x22	OPTO-K305222	KTTO50007, KTTO50061	NRF 38257, NRF 38255	KTTO50164	-
Denso 10PA17C (Mercedes)	35x52x22	OPTO-K355222	KTTO50007, KTTO50061	NRF 38257, NRF 38255	KTTO50163	-
Denso 10PA20	30x52x22	OPTO-K305222	KTTO50009, KTTO50071	NRF 38313	KTTO50165	-
Denso 10S11	30x52x20	OPTO-K305220	KTTO50078	NRF 38467	KTTO50046, KTTO50048	-
Denso 10S13	30x52x22	OPTO-K305222	KTTO50078	NRF 38467	KTTO50047	-
Denso 10S13	30x52x20	OPTO-K305220	KTTO50078	NRF 38467	KTTO50047	-
Denso 10S15/10S17/10S20	30x52x22	OPTO-K305222	KTTO50078	-	KTTO50166, KTTO50044	-
Denso SC06	30x47x20	OPTO-K304720	KTTO50065	4S 2400080	-	-
Denso SC06 (Póžny)	30x47x12	OPTO-K304712	KTTO50065	4S 2400080	-	-
Denso SC08	35x52x20	OPTO-K355220	-	-	-	-
Denso SCS06	30x52x20	OPTO-K305220	KTTO50065	4S 2400080	-	-
Denso TV10C	30x52x22	OPTO-K305222	KTTO50081	-	KTTO50167	-
Denso TV12C(R12)/TV14C	30x52x22	OPTO-K305222	KTTO50064	-	KTTO50085, KTTO50042	-
Denso TV12C(R134a)	30x52x22	OPTO-K305222	KTTO50023	-	KTTO50123	-
Denso TV12C(R12)/TV14EC	30x52x22	OPTO-K305222	KTTO50064	-	KTTO50086, KTTO50049	-
Denso TV125C(R134a)/TV145C	30x52x22	OPTO-K305222	KTTO50023	-	KTTO50124	-
Diesel Kiki DCS17C/DCS17D	35x52x20	OPTO-K355220	KTTO50065	4S 2400080	KTTO50150	-
Diesel Kiki DCV11A/DCV14A	35x55x20	OPTO-K355520	KTTO50026	-	KTTO50139, KTTO50157, KTTO50051	-
Diesel Kiki DCW17	35x62x24	OPTO-K356224	KTTO50065	4S 2400080	KTTO50052	-
Diesel Kiki DKS13CH	35x55x20	OPTO-K355520	KTTO50013	NRF 38251	-	-
Diesel Kiki DKS13G (dvojity)	35x55x20	OPTO-K355520	KTTO50014	-	KTTO50097	-
Diesel Kiki DKS13G (samostat.)	35x55x20	OPTO-K355520	KTTO50014	-	KTTO50170	-
Diesel Kiki DKS13S	35x55x20	OPTO-K355520	KTTO50067	-	KTTO50171	-
Diesel Kiki DKS15BH	35x55x20	OPTO-K355520	KTTO50014	-	KTTO50098	NRF 38297
Diesel Kiki DKS15CH	35x62x28	OPTO-K356228	KTTO50014	-	KTTO50099	NRF 38298
Diesel Kiki DKS15CH	35x55x20	OPTO-K355520	KTTO50013	-	KTTO50099	NRF 38298
Diesel Kiki DKS15CH	35x62x28	OPTO-K356228	KTTO50013	-	KTTO50099	NRF 38298

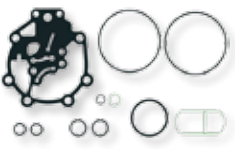
Tabuľka tesnení kompresorov



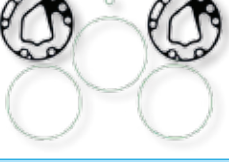









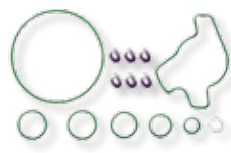







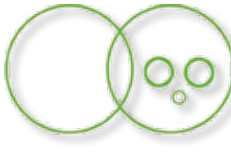
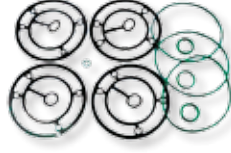

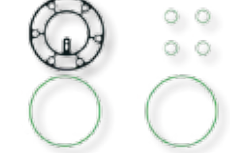





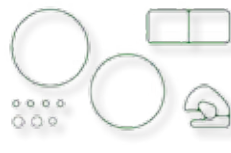
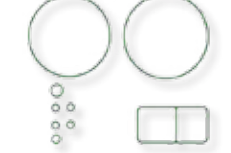









Výrobca	Ložisko	Index ložiska	Hlavné tesnenie	Zámena hlavného tesnenia	Tesnenie tela	Zámena tesnenia tela
Diesel Kiki DKS15G	35x55x20	OPTO-K355520	KTT050014		KTT050170	-
Diesel Kiki DKS15S	35x55x20	OPTO-K355520	KTT050067		KTT050171	-
Diesel Kiki DKS16H(R12)	30x55x23	OPTO-K305523	-	-	KTT050100, KTT050158	-
Diesel Kiki DKS16H(R134a)	30x55x23	OPTO-K305523	KTT050025		KTT050100	-
Diesel Kiki DKS17CH	35x55x20	OPTO-K355520	KTT050013	NRF 38251	KTT050159	-
Diesel Kiki DKS17G (Podwójny)	35x55x20	OPTO-K355520	KTT050014		-	-
Diesel Kiki DKS17G (Pojedynczy)	35x55x20	OPTO-K355520	KTT050014		-	-
Diesel Kiki DKS17S	35x55x20	OPTO-K355520	KTT050067		KTT050172	-
Diesel Kiki DKV11-14G	35x55x20	OPTO-K355520	-	-	KTT050053	-
Diesel Kiki DKV11D	35x55x20	OPTO-K355520	KTT050026		KTT050141	-
Diesel Kiki DKV11G	35x55x20	OPTO-K355520	KTT050070		KTT050053	-
Diesel Kiki DKV14C	40x62x24	OPTO-K406224	KTT050070		KTT050115	-
Diesel Kiki DKV14D	35x55x20	OPTO-K355520	KTT050070		KTT050136	-
Diesel Kiki DKV14G	35x55x20	OPTO-K355520	KTT050070		KTT050053	-
Ford F56	40x62x20,6/24	OPTO-K406220,6/24 A	KTT050007, KTT050028	NRF 38257	KTT050101	-
Ford FS10	30x55x23	OPTO-K305523	KTT050003	9GR351 163-801	KTT050173	-
Ford FX15	30x55x23	OPTO-K305523	KTT050003	9GR351 163-801	KTT050174	NRF 38299
Ford Scroll	35x50x20	OPTO-K355020	KTT050062	NRF 38464	KTT050036	-
GM/Harrison A6	40x62x20,6	OPTO-K406220,6 A	KTT050004, KTT050005	NRF 38418, NRF 38419	KTT050102	NRF 38412
GM/Harrison DA6/HR6/HR6HE	40x62x20,6	OPTO-K406220,6 A	KTT050006	NRF 38253	KTT050103, KTT050143, KTT050144	NRF 38300
GM/Harrison HD6/HT6 (skory)	40x62x20,6	OPTO-K406220,6 A	KTT050006, KTT050059	NRF 38253	KTT050134	-
GM/Harrison HT6 (neskory)/ HU6	40x62x20,6	OPTO-K406220,6 A	KTT050068		KTT050037	-
GM/Harrison R4	40x62x20,6	OPTO-K406220,6 A	KTT050004, KTT050005, KTT050006	NRF 38418, NRF 38419, NRF 38253	KTT050104	NRF 38301
GM/Harrison SP10	38x54x17	OPTO-K385417	KTT050013	NRF 38251	KTT050132	-
GM/Harrison V5	40x62x20,6	OPTO-K406220,6 A	KTT050006, KTT050072	NRF 38253	KTT050105, KTT050152	4S 24507
GM/Harrison V7	40x62x20,6	OPTO-K406220,6 A	KTT050079, KTT050072		KTT050145	-
Hitachi AS000	40x62x24	OPTO-K406224	KTT050074		KTT050092	-
Hitachi MJ110	-	-	-	-	KTT050175, KTT050176	-
Hitachi MJ123	-	-	-	-	KTT050177	-
Hitachi MJ167	-	-	-	-	KTT050178	-
Hitachi MJS130	-	-	-	-	KTT050178	-
Hitachi MJS170	40x62x24	OPTO-K406224	-	-	KTT050106	-
Hitachi SWP123/SWP167	-	-	-	-	KTT050107	-
Honda System RC17D/RC17S	35x55x20	OPTO-K355520	KTT050073		-	-
Keihin 150L	40x62x20,6	OPTO-K406220,6 A	KTT050080		KTT050091	-
Keihin 150R	40x62x20,6	OPTO-K406220,6 A	KTT050080		KTT050091	-
Matsushita H12A1AH4DX	32x47x18	OPTO-K324718	KTT050079		KTT050160	-
Matsushita N1301	32x55x23	OPTO-K325523	KTT050024, KTT050075		KTT050029, KTT050057	-
Matsushita NL1300	32x55x23	OPTO-K325523	KTT050024, KTT050075		KTT050108, KTT050055	-
Matsushita S1150F3/X3	32x55x23	OPTO-K325523	KTT050024		KTT050109	-
Matsushita SA1150AE	32x55x23	OPTO-K325523	KTT050024		KTT050030, KTT050056	NRF 38408
Mitsubishi FX80	40x62x20,6/24	OPTO-K406220,6/24 A	KTT050022, KTT050062	NRF 38254, NRF 38464	KTT050111	-
Mitsubishi FX105V	40x62x20,6/24	OPTO-K406220,6/24 A	KTT050022, KTT050062, KTT050084	NRF 38254, NRF 38464	KTT050110	-
Mitsubishi FXA105	40x57x24	OPTO-K405724	KTT050022, KTT050062	NRF 38254, NRF 38464	KTT050031	-
Mitsubishi MSC90	40x62x24	OPTO-K406224	KTT050022	NRF 38254	KTT050113	-
Mitsubishi MSC90	40x66x24	OPTO-K406624	KTT050062	NRF 38464	-	-
Mitsubishi MSC105	40x62x24	OPTO-K406224	KTT050022	NRF 38254	KTT050112	-
Mitsubishi MSC105	40x66x24	OPTO-K406624	KTT050062	NRF 38464	-	-
Mitsubishi MSC130CVSG	35x50x20	OPTO-K355020	-	-	KTT050058	-
Nihon DCV14C/D	-	-	-	-	KTT050054	-
Nihon DKV14B	30x55x23	OPTO-K305523	KTT050020, KTT050026		KTT050114	-
Nihon DKV14C	40x62x24	OPTO-K406224	KTT050026		KTT050115	-
Nihon NVR140S	30x55x23	OPTO-K305523	KTT050021		KTT050116	-
Sanden PXE13	35x52x20	OPTO-K355220	KTT050065	4S 2400080	KTT050149	-
Sanden PXE16	35x52x20	OPTO-K355220	KTT050065	4S 2400080	KTT050140	-
Sanden SD505	35x55x20	OPTO-K355520	KTT050012		KTT050125	NRF 38307
Sanden SD507/SD508/SD510	40x62x24	OPTO-K406224	KTT050011		KTT050125	NRF 38307
Sanden SD5H13	35x55x20	OPTO-K355520	KTT050013, KTT050065, KTT050076	NRF 38251, 4S 2400080	KTT050125	NRF 38307
Sanden SD6V12	35x55x20	OPTO-K355520	KTT050013	NRF 38251	KTT050146	NRF 38319
Sanden SD708/SD709	35x55x20	OPTO-K355520	KTT050010, KTT050013	NRF 38251	KTT050126, KTT050049	9GR351 150-801
Sanden SD709CA	35x55x20	OPTO-K355520	KTT050013	NRF 38251	KTT050127	-
Sanden SD709CP	35x55x20	OPTO-K355520	KTT050013	NRF 38251	KTT050032	-
Sanden SD7B10	35x50x20	OPTO-K355020	KTT050013	NRF 38251	KTT050128	NRF 38309
Sanden SD7C16	35x52x20	OPTO-K355220	KTT050065	4S 2400080	KTT050155	-
Sanden SD7H13	35x55x20	OPTO-K355520	KTT050013	NRF 38251	-	-
Sanden SD7H15	35x55x20	OPTO-K355520	KTT050013, KTT050065	NRF 38251, 4S 2400080	KTT050126, KTT050049	9GR351 150-801
Sanden SD7V16	35x55x20	OPTO-K355520	KTT050013, KTT050065	NRF 38251, 4S 2400080	KTT050129, KTT050147	NRF 38315, 38320
Sanden TR70	30x47x18	OPTO-K304718	KTT050012, KTT050022	NRF 38254	KTT050087	-
Sanden TRSA09	35x55x20	OPTO-K355520	KTT050062	NRF 38464	KTT050161	-
Sanden TRSA12	35x50x20	OPTO-K355020	KTT050062	NRF 38464	KTT050138	-
Sanden TRSE07	35x48x20	OPTO-K354820 A	KTT050062, KTT050065	NRF 38464, 4S 2400080	KTT050161	-
Sanden TR80	-	-	KTT050011		-	-
Sanden TR90	35x55x20	OPTO-K355520	KTT050012		KTT050033	-
Sanden TR90	35x50x20	OPTO-K355020	KTT050022	NRF 38254	-	-
Sanden TR105	35x50x20	OPTO-K355020	KTT050012, KTT050022	NRF 38254	KTT050148	-
Seiko-Seiki SS10	32x47x18	OPTO-K324718	KTT050065	4S 2400080	KTT050142	-
Seiko-Seiki SS96	32x55x23	OPTO-K325523	KTT050013	NRF 38251	KTT050142	-
Seiko-Seiki SS121DV2	35x55x20	OPTO-K355520	KTT050013	NRF 38251	KTT050034	-
Seiko-Seiki SS170PSS	40x62x24	OPTO-K406224	KTT050008, KTT050060	NRF 38258	KTT050088	-
Tama Zexel TM08	35x55x20	OPTO-K355520	KTT050013, KTT050065	NRF 38251, 4S 2400080	KTT050035	-
Tama Zexel TM13	35x55x20	OPTO-K355520	KTT050013, KTT050065	NRF 38251, 4S 2400080	KTT050050	-
Tama Zexel TM15	35x55x20	OPTO-K355520	KTT050013, KTT050065	NRF 38251, 4S 2400080	KTT050050	-
Tama Zexel TM16	35x55x20	OPTO-K355520	KTT050013, KTT050065	NRF 38251, 4S 2400080	KTT050050	-
Visteon HS090	35x50x20	OPTO-K355020	KTT050062	NRF 38464	KTT050038	-
Visteon VS16	35x55x20	OPTO-K355520	KTT050069		KTT050156	-





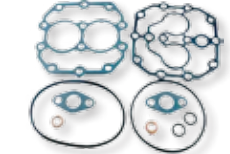

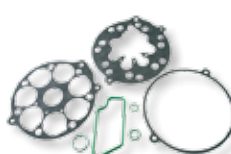



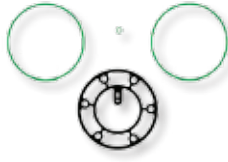
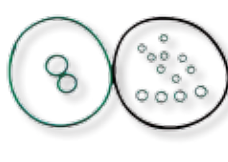
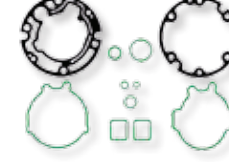

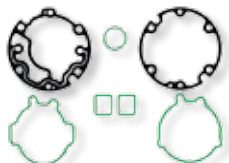
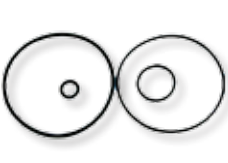

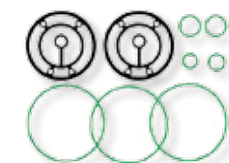
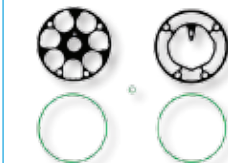
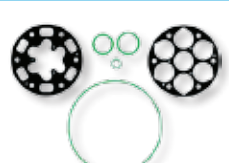



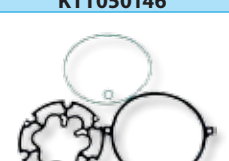
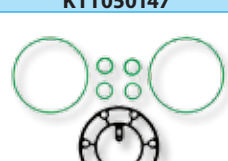





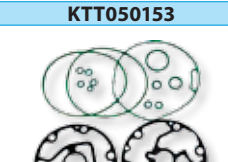
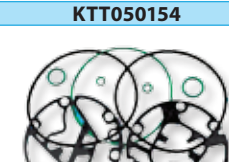

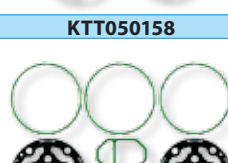
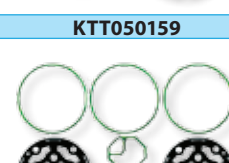
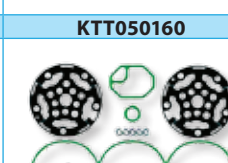
Tabuľka tesnení kompresorov - obrázky a indexy

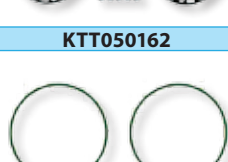
				
KTT050001	KTT050002	KTT050003	KTT050004	KTT050005
				
KTT050006	KTT050007	KTT050008	KTT050009	KTT050010
				
KTT050011	KTT050012	KTT050013	KTT050014	KTT050015
				
KTT050016	KTT050017	KTT050018	KTT050019	KTT050020
				
KTT050021	KTT050022	KTT050023	KTT050024	KTT050025
				
KTT050026	KTT050027	KTT050028	KTT050029	KTT050030
				
KTT050031	KTT050032	KTT050033	KTT050034	KTT050035
				
KTT050036	KTT050037	KTT050038	KTT050039	KTT050040
				
KTT050041	KTT050042	KTT050043	KTT050044	KTT050045

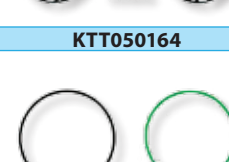
				
KTT050046	KTT050047	KTT050048	KTT050049	KTT050050
				
KTT050051	KTT050052	KTT050053	KTT050054	KTT050055
				
KTT050056	KTT050057	KTT050058	KTT050059	KTT050060
				
KTT050061	KTT050062	KTT050063	KTT050064	KTT050065
				
KTT050066	KTT050067	KTT050068	KTT050069	KTT050070
				
KTT050071	KTT050072	KTT050073	KTT050074	KTT050075
				
KTT050076	KTT050077	KTT050078	KTT050079	KTT050080
				
KTT050081	KTT050082	KTT050083	KTT050084	KTT050085
				
KTT050086	KTT050087	KTT050088	KTT050089	KTT050090

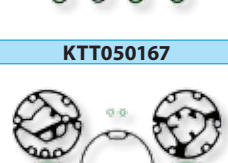
Tabuľka tesnení kompresorov

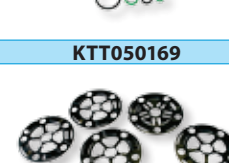
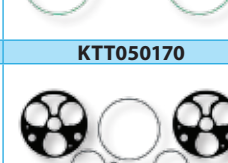
				
KTT050091	KTT050092	KTT050093	KTT050094	KTT050095
				
KTT050096	KTT050097	KTT050098	KTT050099	KTT050100
				
KTT050101	KTT050102	KTT050103	KTT050104	KTT050105
				
KTT050106	KTT050107	KTT050108	KTT050109	KTT050110
				
KTT050111	KTT050112	KTT050113	KTT050114	KTT050115
				
KTT050116	KTT050117	KTT050118	KTT050119	KTT050120
				
KTT050121	KTT050122	KTT050123	KTT050124	KTT050125
				
KTT050126	KTT050127	KTT050128	KTT050129	KTT050130
				
KTT050131	KTT050132	KTT050133	KTT050134	KTT050135

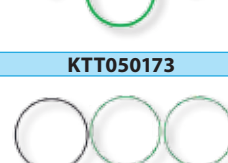
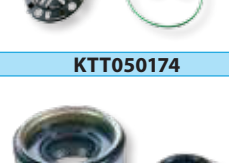
				
KTT050136	KTT050137	KTT050138	KTT050139	KTT050140
				
KTT050141	KTT050142	KTT050143	KTT050144	KTT050145
				
KTT050146	KTT050147	KTT050148	KTT050149	KTT050150
				
KTT050151	KTT050152	KTT050153	KTT050154	KTT050155
				obrázok nie je k dispozícii
KTT050156	KTT050157	KTT050158	KTT050159	KTT050160
				
KTT050161	KTT050162	KTT050163	KTT050164	KTT050165
				
KTT050166	KTT050167	KTT050168	KTT050169	KTT050170
				
KTT050171	KTT050172	KTT050173	KTT050174	KTT050175
				
KTT050176	KTT050177	KTT050178	KTT050179	









Regulačné ventily kompresorov

V tabuľke sú prezentované najčastejšie regulačné ventily v aktuálnej ponuke. Viacej ventilov nájdete v katalógoch výrobcov z tabuľky:



Výrobca	Tlačený katalóg		Elektronický katalóg CD		Katalóg on-line	Tec Doc	Príklad indexu tovaru
	Vydanie	Index IC	Vydanie	Index IC			
	2009/2010	002491 011	2008/2009	002491 009	www.hella.sk	✓	8FA351 137-051
	2009	002518 027	2010	002518 028	—	✓	004032/2
	2009/2010	002629 002	—	—	www.nrf.nl	✓	NRF 38420

Regulačné ventily kompresorov				
Index	Zámena	Použitie	Číslo OE kompresora, v ktorom možno ventil použiť	Obrázok
KTT060001		SANDEN PXE16 uchytenie krúžkom, spoje na vedení (AUDI/SEAT/SKODA/VW)	1K0820803G, 1K0820803M, 1K0820803Q, 1K0820803S	
KTT060002	V15-77-1013	SANDEN PXE13/PXE16 uchytenie skrutka, spoje na vedení, ventil skrutka (AUDI/SEAT/SKODA/VW)	1K0820803G, 1K0820803M, 1K0820803Q, 1K0820803S	
KTT060003		SANDEN PXE13/PXE16 uchytenie skrutka, spoje na ventile	1K0820803G, 1K0820803M, 1K0820803Q, 1K0820803S	
KTT060004	V15-77-1014	SANDEN PXE16 uchytenie krúžkom, spoje na ventile	1K0820803G, 1K0820803M, 1K0820803Q, 1K0820803S	
KTT060005		DENSO 5SE09C/5SE12C	447190-310, 447190-454, 9644727-073, 447260-049	
KTT060006		DENSO 5SE09C/5SE12C	447190-320, 447260-054, 447190-245, 447190-394, 447190-455, 447260-055	
KTT060007	NRF 38460	DENSO 6SEU12/6SEU16/7SEU16	447190-337, .0012301311, 0012307911, 447170-833, 447180-704, 447180-447	
KTT060008		DENSO 5SE09C/5SE12C	447190-334	
KTT060009		DENSO 6SEU12/6SEU16/7SEU16		
KTT060010		DENSO 6SEU12/6SEU16/7SEU16		
KTT060011		DENSO 6SEU16C		
KTT060012		DENSO 6SEU16C		
KTT060013		DENSO 7SEU16C (VW Passat)		
KTT060014		DENSO 7SB16/7SBU16		
KTT060015		DENSO 5SE12/6SEU16		
KTT060016		DENSO 5SA12/5SL12/5SA09/6SBU16/7SBU16		
KTT060017		DENSO 6C17/6CA17C/7SB16C		
KTT060018		ZEXEL DCW17 - vnútorný ventil	506031-0781, 8D0260805D, 8D0260805F, 8D0260805M	
KTT060019		DELPHI/HARRISON V5 (RENAULT LAGUNA/SCENIC/SPACE)	1135320, 8200021822, 1135321, 8200024397	
KTT060020		SANDEN 7C16/6C16 (Citroen/Peugeot)		
KTT060021		ZEXEL DCS17E - regulačný ventil kompresora	1K0820803H, 1K0820803L, 1K0820803N, 1K0820803NX, 1K0820859	

Regulačné ventily kompresorov				
Index	Zámena	Použitie	Číslo OE kompresora, v ktorom možno ventil použiť	Obrázok
KTT060022		FORD Scroll	1084732, RXS7H19D629EA, XS7H19D629EA, YS7H19D629BA, RXS7H19D629BA, RXS7H19D629BB	
KTT060023	NRF 38421	GM/HARRISON V5	1135025, 1135295, 1135323, 1854032, 1854094, 1854105	
KTT060024		SANDEN SD7V12 /SD6V12	1J0820803A, 1J0820805, 1J0820803F, 1J0820803K, 7M0820803R, 7M3820803	
KTT060025		CALSONIC CSV717		
KTT060026		DENSO 6SEU12/6SEU16/7SEU16	447170-764, 447180-286, 447220-836, 9744728-836, 447220-887, .0002305911	
KTT060027		DENSO 6SEU12/6SEU16/7SEU16	447180-959, 447180-626, 447180-570, 447180-350, 447260-017, 447260-128	
KTT060028		DENSO 7SEU16/7SEU17	447180-862, 7H0 820 805 C, 7H0 820 805 E, 7H0 820 805 F, 7H0 820 805 G, 7H0 820 805 H	
KTT060029		DENSO 5SE09C/5SE12C		
KTT060030		DENSO 5SE09C/5SE12C	447180-664, 447180-5240, 447180-5241, 000 230 91 11, 001 230 02 11, 001 230 08 11	

POZOR! Kompresory vybavené regulačnými ventilmi sa nesmú kontrolovať na tesnosť použitím tlaku plynu nad 8 Bar / 100 psi. Takáto kontrola môže viesť k poškodeniu ventilu!



Invert
Garage Equipment

FULL
Automatic
AC Station

www.decodedesign.it 19 02 11

SPIN RIMINI **MADE IN ITALY**

Kondenzátory, výparníky, sušiče

Za účelom zistenia správneho dielu tohto sortimentu použite nižšie uvedené katalógy výrobcov:

Výrobca	Tlačený katalóg		Elektronický katalóg CD		Katalóg on-line	Tec Doc	Príklad indexu tovaru
	Vydanie	Index IC	Vydanie	Index IC			
	2009/2010	002491 011	2008/2009	002491 009	www.hella.sk	✓	Kondenzátor - 8FC351 037-161 Výparník - 8FV351 211-061 Sušič - 8FT351 192-041
	2010	002518 027	2009	002518 028	—	✓	Kondenzátor - TSP0225073 Výparník - TSP0525033 Sušič - TSP0175047
	2009/2010	279514 000	—	—	http://www.4s-europe.com	—	Kondenzátor - 4S 53146 Sušič 4S 83901
	2008/2009	002628 012	2009/2010	002628 011	www.nissens.com	✓	Kondenzátor - 8FV351 211-061 Výparník - NIS 92161 Sušič - NIS 95343
	2009/2010	002629 002	—	—	www.nrf.nl	✓	Kondenzátor - NRF 35524 Výparník - NRF 36077 Sušič - NRF 33114
	2010	002717 025	—	—	www.valeo.com	✓	Kondenzátor - VAL817524 Sušič - VAL509525

Kondenzátory - „chladiče klimatizácie“

Opel Astra G 1.2 - 1.7TD - 2.0 - 2.0DTL
OE: 09119176, 1850055, 1850057

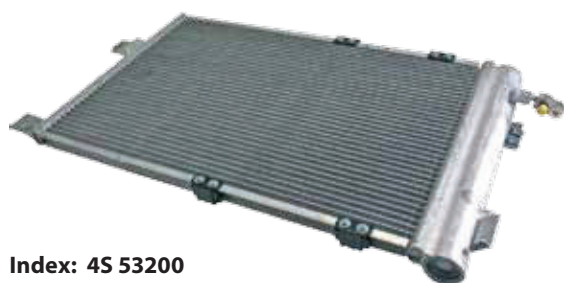

Index: 4S 53200
MOC: 99,2 €
Cena s DPH: 119 €

Opel Astra H 1.9 CDTI 04-
OE: 1850111, 93182213



Index: NIS 940052
MOC: 197 €
Cena s DPH: 236,4 €

i Chladič klimatizácie (Kondenzátor) je tou časťou systému, z ktorého je veľmi ťažké vypláchnuť nečistoty rôznych druhov, napr. po zadretí kompresora. Preto sa odporúča, aby bola táto časť taktiež vymenená za novú počas opravy systému klimatizácie po poruche.

Výparník

FORD FOCUS 98 ->
OE: 1062481, 1068129, 1108118,
1122802, XS4H19850AA,
XS4H19850AB, YS4H19850AA,
YS4H19850BA,
YS4H19850CA



Index: NRF 36073
MOC: 112 €
Cena s DPH: 134,4 €

AUDI A4 01/95 ->
OE: 8D1820103C, 8D1820103B,
8D1820103D



Index: 8FV351 211-061
MOC: 125 €
Cena s DPH: 150 €

Sušič

Mercedes W210 / T210 E-class 1995-2003
OE: 2108300283, 2108300483



Index: 4S 33704
MOC: 15,4 €
Cena s DPH: 18,5 €

i Výrobca systémov klimatizácie odporúča výmenu sušiča pravidelne každé 2 roky, ako aj automaticky po každej oprave alebo otvorení systému. Nepriechodný sušič spôsobuje poruchy systému klimatizácie.

"HOT" díly pro klimatizace

Připravte se na sezónu s jedním z nejširších sortimentů dílů do klimatizací



NEJŠIRŠÍ SORTIMENT NA AFTERMARKETU PRO CHLAZENÍ MOTORU A DÍLŮ KLIMATIZACE NA AUTOMOBILY I NÁKLADNÍ VOZY.

AUTOMOTIVE PARTS FOR ENGINE COOLING & CLIMATE
HIGH QUALITY

Vyberte si z více než 3.000 velice kvalitních produktů pro automobily i nákladní automobily

- kondenzátory, vysoušeče, výparníky a topení.

Nabízíme vám nejširší sortiment na aftermarketu při kvalitě OE garantovanou standardy ISO 9001 / TS 16949.

Nissens

Škrtiace trysky, ventily



Výrobca	Tlačený katalóg		Elektronický katalóg CD		Katalóg on-line	Tec Doc	Príklad indexu tovaru
	Vydanie	Index IC	Vydanie	Index IC			
BEHR HELIX SERVICE	2009/2010	002491 011	2008/2009	002491 009	www.hella.sk	✓	8UW351 233-091
DELPHI	2010	002518 027	2009	002518 028	—	✓	TSP0585009
4 SEASONS	2009/2010	279514 000	—	—	http://www.4s-europe.com	—	4S 38884
Valeo	2010	002717 025	—	—	—	✓	VAL509489

Expanzný ventil Fiat, Ford, Seat, VW

Index: TSP0585009



Spinka (uchytenie) expanzného ventilu

Index: 4S 2400029



Tabuľka najčastejšie používaných ventilov

Index	Použitie	Tryska - farba	O-ring farba	Počet O-ringov	Priemer	Obrázok
8UW351 233-001	Audi, Jaguar, Volvo, Opel, GM, Rolls Royce	neutrálny / biely	čierny	1	1,828mm	
8UW351 233-041	Ford	bronz / neutrálny	zelený	2	1,193mm	
8UW351 233-051	Opel, GM, Volvo	čierny / biely	čierny	1	1,828mm	
8UW351 233-061	Ford, Nissan	modrý / biely	zelený	2	1,701mm	
8UW351 233-071	Ford, Nissan, Hyundai	pomarančový / biely	zelený	2	1,447mm	
8UW351 233-081	Ford, Mazda	červený / biely	červený	2	1,572mm	
8UW351 233-091	Ford, GM, Opel, VW, Audi	žltý / biely	čierny	1	1,574mm	
8UW351 233-111	Chrysler, Jeep, Dodge	fialový / biely	zelený	2	1,574mm	
8UW351 233-131	Ford	zelený	zelený	2	1,320mm	

Ventilátory a motorčky

Za účelom zistenia správneho dielu tohto sortimentu použite nižšie uvedené katalógy výrobcov:

Výrobca	Tlačený katalóg		Elektronický katalóg CD		Katalóg on-line	Tec Doc	Príklad indexu tovaru
	Vydanie	Index IC	Vydanie	Index IC			
Autogamma	—	—	—	—	—	—	GA201197
BEHR HELIX SERVICE	2009/2010	002491 011	2008/2009	002491 009	www.hella.sk	✓	8EW009 159-581
HANS PRIES	2008/2009	002558 009 - AUDI/SEAT/SKODA/VW, 002558 010 - MERCEDES, 002558 011 - OPEL, 002558 012 - BMW/MINI, 002558 013 - PEUGEOT/CITROEN	—	—	www.pries.de	✓	HP109 604
MAGNETI MARELLI aftermarket	—	—	—	—	www.magnetimarelli-checkstar.pl/ produkty/czesci,5,2,18,18	✓	069401252010
Nissens <small>DELIVERING THE DIFFERENCE</small>	2008/2009	002628 012	2008/2009	002628 011	www.nissens.com	✓	NIS 85519
TYC	—	—	—	—	—	✓	TYC 826-0004
Valeo	2010	002717 025	—	—	www.valeo.com	✓	VAL698806

Ventilátor chladiča

Ventilátor chladiča (vrátane krytu)

Fiat Punto 1.1/1.2 09.93-09.99

OE:



Index: GA201197

MOC: 58,4 €
Cena s DPH: 70 €

Ventilátor chladiča

Peugeot 206 1.1i-2.0 S16 09.98-

OE: 1253C9, 1253E0



Index: TYC 826-0004

MOC: 80,6 €
Cena s DPH: 96,7 €

Vnútrotný ventilátor

Vnútrotný ventilátor

Mercedes VITO 10/95-

OE: 0028301508



Index: VAL698217

MOC: 125 €
Cena s DPH: 150 €

Vnútrotný ventilátor

Citroen Xsara Picasso; Peugeot 206 2000-> (klimatronic)

OE: 6441K03, 6441K0



Index: 8EW009 159-581

MOC: 115 €
Cena s DPH: 138 €

Senzory, spínače, krokové motorčky

Za účelom zistenia správneho dielu tohto sortimentu použite nižšie uvedené katalógy výrobcov:

Výrobca	Tlačený katalóg		Elektronický katalóg CD		Katalóg on-line	Tec Doc	Príklad indexu tovaru
	Vydanie	Index IC	Vydanie	Index IC			
	2009/2010	002491 011	2008/2009	002491 009	www.hella.sk	✓	6ZL351 028-221
	2010	002518 027	2009	002518 028	—	✓	TSP0435035
	2009/2010	002629 002	—	—	www.nrf.nl	✓	NRF 38900
	2010	002717 025	—	—	www.valeo.com	✓	VAL508830

Tabuľka najpredávanejších krokových motorčiek

Index: VAL509222	Použitie: Peugeot 406		Index: VAL509603	Použitie: Renault Scenic II	
Index: VAL509227	Použitie: Renault Megane		Index: VAL509357	Použitie: Citroen C5	
Index: VAL509229	Použitie: Renault 19		Index: VAL509573	Použitie: Seat Cordoba, Ibiza, Leon	
Index: VAL509507	Použitie: Citroen C2, C3		Index: VAL509572	Použitie: Seat Leon, Toledo	

Senzor tlaku

Opel Astra G, VECTRA B/C; Fiat
OE: 9131721, 6850512, 12799379



Index: NRF 38937
MOC: 48,2 €
Cena s DPH: 57,8 €

Diel riadenia klimatizácie

BMW 5 E39, X5
OE: 64116923204, 64116929486



Index: VAL509505
MOC: 62,7 €
Cena s DPH: 75,2 €

Vedenia, hadice

Ponuka vedení do systémov klimatizácie vo vozidlách zahŕňa presne vyhotovené vedenia, určené danej značke a modelu auta, ako aj vedenia a hadice univerzálne. Ich výber uľahčuje tabuľka nižšie. Vedenia pre dané značky treba hľadať v nižšie uvedených katalógoch výrobcov alebo na základe čísiel OE.

Výrobca	Tlačený katalóg		Elektronický katalóg CD		Katalóg on-line	Tec Doc	Príklad indexu tovaru
	Vydanie	Index IC	Vydanie	Index IC			
	2009/2010	002491 011	2008/2009	002491 009	www.hella.com	✓	Vedenie pre: 9GS351 191-081; Hadica v rolke: 9GS351 189-041
	2010	002518 027	2009	002518 028	—	✓	Hadica v rolke: SSP90006G2G20
	2009/2010	279514 001	—	—	www.4s-europe.com/uk	—	Hadica v rolke: 4S 55106
	2010	002717 025	—	—	www.valeo.com	✓	Vedenie pre: VAL818401

Vedenia pevné - hliníkové

Index Behr Hella	Nr	Vnútorý priemer Inch/ mm	Vonkajší priemer Inch/ mm	Dĺžka
9XL351 043-041	4	0,17" / 4,42mm	0,25" / 6,35 mm	1m
9XL351 043-001	6	0,28" / 7mm	0,38" / 9,53 mm	1m
9XL351 043-011	8	0,40" / 10,2 mm	0,50" / 12,65 mm	1m
9XL351 043-021	10	0,53" / 13,4 mm	0,62" / 15,85 mm	1m
9XL351 043-031	12	0,64" / 16,3 mm	0,75" / 19,05 mm	1m

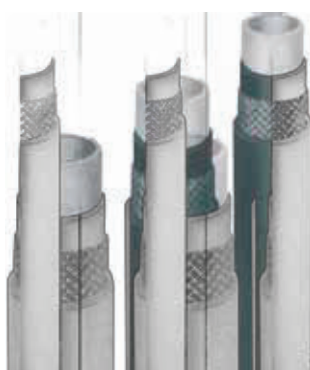

Elastické vedenia - tenkostenné

Index Behr Hella	Nr	Vnútorý priemer Inch/ mm	Vonkajší priemer Inch/ mm	Dĺžka
9GS351 190-041	6	0,3-0,33" / 7,62-8,38 mm	0,56-0,6" / 14,22-15,75 mm	1,5 m
9GS351 190-001	6	0,3-0,33" / 7,62-8,38 mm	0,56-0,6" / 14,22-15,75 mm	15 m
9GS351 190-051	8	0,4-0,44" / 10,16-11,18 mm	0,66-0,7" / 16,76-17,78 mm	1,5 m
9GS351 190-011	8	0,4-0,44" / 10,16-11,18 mm	0,66-0,7" / 16,76-17,78 mm	15 m
9GS351 190-061	10	0,49-0,53" / 12,44-13,46 mm	0,745-0,785" / 18,92-19,94 mm	1,5 m
9GS351 190-021	10	0,49-0,53" / 12,44-13,46 mm	0,745-0,785" / 18,92-19,94 mm	15 m
9GS351 190-071	12	0,615-0,655" / 15,62-16,64 mm	0,91-0,95" / 23,11-24,13 mm	1,5 m
9GS351 190-031	12	0,615-0,655" / 15,62-16,64 mm	0,91-0,95" / 23,11-24,13 mm	15 m



Elastické vedenia - štandardné, hrubostenné

Index Behr Hella	Nr	Vnútorý priemer Inch/ mm	Vonkajší priemer Inch/ mm	Dĺžka
9GS351 189-071	6	0,305-0,335" / 7,75-8,51 mm	0,719-0,781" / 18,26-19,84 mm	1,5 m
9GS351 189-041	6	0,305-0,335" / 7,75-8,51 mm	0,719-0,781" / 18,26-19,84 mm	15 m
9GS351 189-081	8	0,4-0,44" / 10,16-11,18 mm	0,875-0,937" / 22,22-23,8 mm	1,5 m
9GS351 189-051	8	0,4-0,44" / 10,16-11,18 mm	0,875-0,937" / 22,22-23,8 mm	15 m
9GS351 189-091	10	0,489-0,535" / 12,42-13,59 mm	0,969-1,031" / 24,61-26,19 mm	1,5 m
9GS351 189-061	10	0,489-0,535" / 12,42-13,59 mm	0,969-1,031" / 24,61-26,19 mm	15 m
9GS351 189-111	12	0,614-0,66" / 15,6-16,76 mm	1,096-1,125" / 27,84-28,58 mm	1,5 m
9GS351 189-101	12	0,614-0,66" / 15,6-16,76 mm	1,096-1,125" / 27,84-28,58 mm	15 m

Vedenie na mieru

Vedenie klimatizácie
Opel Vectra B
OE: 24436605, 68 50 467, 68 50 656



Index: 9GS351 191-081

MOC: 117 €

Cena s DPH: 140,4 €

Produkty na opravu vedení klimatizácie







V nižšie uvedených tabuľkách sú najpoužívanější produkty rôzneho druhu používané na opravy vedení, tak pevných aj elastických. Ďalšie, menej predávané produkty hľadajte v katalógoch výrobcov uvedených tu:

Výrobca	Tlačený katalóg		Elektronický katalóg CD		Katalóg on-line	Tec Doc	Príklad indexu tovaru
	Vydanie	Index IC	Vydanie	Index IC			
	2009/2010	002491 011	2008/2009	002491 009	www.hella.sk	✓	8FF351 045-021
	2010	002518 027	2010	002518 028	—	✓	0695175/0
	2009/2010	279514 001	—	—	http://www.4s-europe.com	—	4S 16818

Tabuľka spojok typu BEADLOCK

Popis a obrázok	Index tovaru	Rozmery		Materiál	Popis a obrázok	Index tovaru	Rozmery		Materiál	
	8FF351 051-111	nr.4	9/16"-18	al		8FF351 054-051	nr.6	5/8"-18	oceľ	
	8FF351 051-001	nr.6	5/8"-18	al		8FF351 054-061	nr.8	3/4"-16	oceľ	
	8FF351 051-121	nr.6	5/8"-18	oceľ		8FF351 054-071	nr.10	7/8"-14	oceľ	
	8FF351 051-011	nr.8	3/4"-16	al		8FF351 048-001	nr.6	5/8"-18	Hliník	
	8FF351 051-041	nr.8->nr.6	3/4"-16 -> nr.6	al		8FF351 048-011	nr.8	3/4"-16	Hliník	
	8FF351 051-131	nr.8	3/4"-16	oceľ			8FF351 065-001	nr.6	5/8"-18	Hliník
	8FF351 051-021	nr.10	7/8"-14	al			8FF351 065-011	nr.8	3/4"-16	Hliník
	8FF351 051-141	nr.10	7/8"-14	oceľ			8FF351 065-021	nr.10	7/8"-14	Hliník
8FF351 051-031	nr.12	17/16"-14	al	8FF351 065-031	nr.12		17/16"-14	Hliník		
8FF351 055-011	nr.6	M18-1,5	al		8FF351 093-001		nr.4	M14	Hliník	
8FF351 055-021	nr.6	M20-1,5	al		8FF351 093-011		nr.6	M16-1,5	Hliník	
8FF351 055-031	nr.8	M20-1,5	al		8FF351 093-021		nr.6	M18-1,5	Hliník	
8FF351 055-041	nr.10	M22-1,5	al		8FF351 093-031	nr.6	M20-1,5	Hliník		
8FF351 055-051	nr.10	M24-2,0	al	8FF351 093-051	nr.10	M22-1,5	Hliník			
8FF351 055-061	nr.12	M27-2,0	al		8FF351 066-001	nr.6	5/8"-18	Hliník		
	8FF351 051-081	nr.6 nízky tlak	5/8"-18		al	8FF351 066-011	nr.8	3/4"-16	Hliník	
	8FF351 051-101	nr.6 vysoký tlak	7/8"-14		al	8FF351 066-021	nr.10	7/8"-14	Hliník	
	8FF351 052-001	nr.6	5/8"-18	Hliník		8FF351 067-001	nr.6	5/8"-18	Hliník	
	8FF351 052-081	nr.6	5/8"-18	oceľ		8FF351 067-011	nr.8	3/4"-16	Hliník	
	8FF351 052-011	nr.8	3/4"-16	Hliník		8FF351 067-021	nr.10	7/8"-14	Hliník	
	8FF351 052-091	nr.8	3/4"-16	oceľ		8FF351 062-001	nr.6	5/8"-18	Hliník	
	8FF351 052-021	nr.10	7/8"-14	Hliník		8FF351 062-011	nr.8	3/4"-16	Hliník	
	8FF351 052-101	nr.10	7/8"-14	oceľ		8FF351 062-021	nr.10	7/8"-14	Hliník	
8FF351 052-031	nr.12	17/16"-14	Hliník	8FF351 062-031		nr.12	17/16"-14	Hliník		
	8FF351 056-001	nr.4	M16-1,5	Hliník		8FF351 063-001	nr.6	5/8"-18	Hliník	
	8FF351 056-011	nr.6	M18-1,5	Hliník		8FF351 063-011	nr.8	3/4"-16	Hliník	
	8FF351 056-021	nr.6	M20-1,5	Hliník			8FF351 064-011	nr.8	3/4"-16	Hliník
	8FF351 056-031	nr.8	M20-1,5	Hliník	8FF351 064-021		nr.10	7/8"-14	Hliník	
	8FF351 056-041	nr.10	M22-1,5	Hliník	8FF351 064-031		nr.12	17/16"-14	Hliník	
	8FF351 056-051	nr.10	M24-2,0	Hliník		8FF351 053-041	nr.8 -> nr.6	3/4"-16 -> nr.6	Hliník	
8FF351 056-061	nr.12	M27-2,0	Hliník	8FF351 058-021		nr.10 -> nr.12	7/8"-14 -> nr.12	Hliník		
8FF351 053-011	nr.4	9/16"-18	Hliník	8FF351 058-011		nr.12 -> nr.10	17/16"-14 -> nr.10	Hliník		
	8FF351 053-001	nr.6	5/8"-18	Hliník		8FF351 057-001	nr.4	M16-1,5	Hliník	
	8FF351 053-131	nr.6	5/8"-18	oceľ		8FF351 057-011	nr.6	M18-1,5	Hliník	
	8FF351 053-011	nr.8	3/4"-16	Hliník		8FF351 057-021	nr.6	M20-1,5	Hliník	
	8FF351 053-021	nr.10	7/8"-14	Hliník	8FF351 057-031	nr.8	M20-1,5	Hliník		
	8FF351 053-151	nr.10	7/8"-14	oceľ	8FF351 057-041	nr.10	M22-1,5	Hliník		
	8FF351 053-031	nr.12	17/16"-14	Hliník	8FF351 057-051	nr.10	M24-2,0	Hliník		
	8FF351 057-001	nr.4	M16-1,5	Hliník	8FF351 057-061	nr.12	M27-2,0	Hliník		
	8FF351 057-011	nr.6	M18-1,5	Hliník		8FF351 053-081	nr.6 vysoký tlak	5/8"-18	Hliník	
	8FF351 057-021	nr.6	M20-1,5	Hliník		8FF351 053-091	nr.8 vysoký tlak	3/4"-16	Hliník	
8FF351 057-031	nr.8	M20-1,5	Hliník	8FF351 053-101		nr.10 nízky tlak	7/8"-14	Hliník		
8FF351 057-041	nr.10	M22-1,5	Hliník							
8FF351 057-051	nr.10	M24-2,0	Hliník							
8FF351 057-061	nr.12	M27-2,0	Hliník							







Tabuľka spojok typu BEADLOCK (pokračovanie predchádzajúcej strany)







Popis a obrázok	Index tovaru	Rozmery		Materiál	Popis a obrázok	Index tovaru	Rozmery		Materiál
 samíčka o-ring redukované rovné	8FF351 074-001	nr 6	5/8"-18	Hliník	 samček o-ring, redukované rovné	8FF351 080-001	nr 6	5/8"-18	Hliník
	8FF351 074-011	nr 8	3/4"-16	Hliník		8FF351 080-011	nr 8	3/4"-16	Hliník
	8FF351 074-021	nr 10	7/8"-14	Hliník		8FF351 080-021	nr 10	7/8"-14	Hliník
	8FF351 074-031	nr 12	17/16"-14	Hliník		8FF351 080-031	nr 12	17/16"-14	Hliník
 samíčka o-ring, redukované 45°	8FF351 075-001	nr 6	5/8"-18	Hliník	 samček o-ring, redukované 90°	8FF351 082-001	nr 6	5/8"-18	Hliník
	8FF351 075-011	nr 8	3/4"-16	Hliník		8FF351 082-011	nr 8	3/4"-16	Hliník
	8FF351 075-021	nr 10	7/8"-14	Hliník		8FF351 082-021	nr 10	7/8"-14	Hliník
 samíčka o-ring, redukované 90°	8FF351 076-001	nr 6	5/8"-18	Hliník	 samček redukované 90°	8FF351 079-001	nr 6	5/8"-18	Hliník
	8FF351 076-011	nr 8	3/4"-16	Hliník		8FF351 079-011	nr 8	3/4"-16	Hliník
	8FF351 076-021	nr 10	7/8"-14	Hliník		8FF351 079-021	nr 10	7/8"-14	Hliník
	8FF351 076-031	nr 12	17/16"-14	Hliník					









Tabuľka spojok typu SPLICER

Popis a obrázok	Index tovaru	Rozmery		Materiál	Popis a obrázok	Index tovaru	Rozmery		Materiál
 rovné	8FF351 061-061	nr 6		Hliník	 trojuholník typu T	8FF351 070-011	3x nr. 6		Hliník
	8FF351 061-071	nr 8		Hliník		8FF351 070-021	3x nr. 8		Hliník
	8FF351 061-081	nr 10		Hliník		8FF351 070-031	3x nr.10		Hliník
	8FF351 061-121	nr 12		Hliník		8FF351 070-041	3x nr.12		Hliník
 rovné s servisným spojom	8FF351 061-001	nr 6 vysoký tlak		Hliník	 splicer skladaný - kužel samček	4S 11106	nr.6		Hliník
	8FF351 061-011	nr 8 vysoký tlak		Hliník		4S 11108	nr.8		Hliník
	8FF351 061-021	nr 10 nízky tlak		Hliník		4S 11110	nr.10		Hliník
				Hliník		4S 11112	nr.12		Hliník
 rovné s servisným spojom 1/4" SAE	8FF351 061-091	nr 6		Hliník	 splicer skladaný - kužel samček 90°	4S 11906	nr.6		Hliník
	8FF351 061-101	nr 8		Hliník		4S 11908	nr.8		Hliník
	8FF351 061-111	nr 10		Hliník		4S 11910	nr.10		Hliník
				Hliník		4S 11912	nr.12		Hliník
 rovné redukované	8FF351 061-231	nr 6		Hliník	 splicer skladaný na zvaranie	4S 12381	nr.6		ocel'
	8FF351 061-241	nr 8		Hliník		4S 12382	nr.8		ocel'
	8FF351 061-251	nr 10		Hliník		4S 12383	nr.10		ocel'
	8FF351 061-261	nr.12		Hliník		4S 12384	nr.12		ocel'
 rovné redukované s servisným spojom	8FF351 061-211	nr 6 vysoký tlak		Hliník	 splicer skladaný obojstranný	4S 12406	6 x 8 - 5/16" x 13/32"		Hliník
	8FF351 061-201	nr 8 vysoký tlak		Hliník		4S 12408	8 x 10 - 13/32" x 1/2"		Hliník
	8FF351 061-191	nr 10 nízky tlak		Hliník		4S 12410	10 x 12 - 1/2" x 5/8"		Hliník
				Hliník					
 rovné redukčné	8FF351 061-031	nr 6 --> nr 8		Hliník	 splicer skladaný samček závitový	4S 13806	6 - 3/8" - 5/8"-18		Hliník
	8FF351 061-041	nr 8 --> nr 10		Hliník		4S 13808	8 - 1/2" - 3/4"-16		Hliník
	8FF351 061-051	nr 10 --> nr 12		Hliník		4S 13810	10 - 5/8" - 7/8"-14		Hliník
				Hliník		4S 13812	12 - 3/4" - 1-1/16"-14		Hliník
 rovné redukčné s servisným spojom	8FF351 061-131	nr.6 --> nr. 8 vysoký tlak		Hliník					

Tabuľka spojok typu SPRING-LOCK

Popis a obrázok	Index tovaru	Rozmery		Materiál	Popis a obrázok	Index tovaru	Rozmery		Materiál
 samíčka rovná	4S 17916	nr.6		Hliník	 samček rovné	8FF351 059-001	nr.6		Hliník
	4S 17918	nr.8		Hliník		4S 17958	nr.8		Hliník
	4S 17920	nr.10		Hliník		4S 17960	nr.10		Hliník
	8FF351 059-071	nr.12		Hliník		8FF351 059-031	nr.12		Hliník
 samíčka 45°	4S 17926	nr.6		Hliník	 samček 45°	4S 17956	nr.6		Hliník
	4S 17928	nr.8		Hliník		4S 17958	nr.8		Hliník
	4S 17930	nr.10		Hliník		4S 17960	nr.10		Hliník
	4S 17932	nr.12		Hliník		4S 17962	nr.12		Hliník
 samíčka 90°	4S 17936	nr.6		Hliník	 samček 90°	4S 17906	nr.6		Hliník
	4S 17938	nr.8		Hliník		4S 17908	nr.8		Hliník
	4S 17940	nr.10		Hliník		8FF351 060-021	nr.10		Hliník
	4S 17942	nr.12		Hliník		4S 17912	nr.12		Hliník

Tabuľka spojok typu LOCKRING							
Popis a obrázok	Index tovaru	Rozmery	Materiál	Popis a obrázok	Index tovaru	Rozmery	Materiál
hliníkové rúrky s beadlockiem 	8FF351 096-121	9,53 mm	Hliník	rovné locking + beadlock 	8FF351 096-081	9,53 mm	Hliník
	8FF351 096-131	13 mm	Hliník		8FF351 096-381	10 mm	Hliník
	8FF351 096-421	16 mm	Hliník		8FF351 096-391	12 mm	Hliník
	8FF351 096-431	19 mm	Hliník		8FF351 096-091	13 mm	Hliník
rovné spojky locking 	8FF351 096-161	6 mm	Hliník		8FF351 096-411	15 mm	Hliník
	8FF351 096-171	8 mm	Hliník		8FF351 096-101	16 mm	Hliník
	8FF351 096-001	9,53 mm	Hliník		8FF351 096-111	19 mm	Hliník
	8FF351 096-011	10 mm	Hliník	lokring s spojkou 1/4" SAE 	8FF351 096-221	9,53 mm	Hliník
	8FF351 096-021	12 mm	Hliník				
	8FF351 096-031	13 mm	Hliník				
	8FF351 096-341	15 mm	Hliník				
	8FF351 096-041	16 mm	Hliník				
	8FF351 096-441	18 mm	Hliník				
8FF351 096-451	19 mm	Hliník	lokring s servisným spojom 	4S 1600016	9,53 mm vysoký tlak	Hliník	
rovné spojky locking redukčné 	8FF351 096-181	9,53 / 6 mm		Hliník	4S 1600017	10 mm vysoký tlak	Hliník
	8FF351 096-151	9,53 / 8 mm		Hliník	4S 1600018	12 mm nízky tlak	Hliník
	8FF351 096-061	13 / 9,5 mm		Hliník	4S 1600019	13 mm nízky tlak	Hliník
	8FF351 096-361	13 / 12 mm		Hliník	8FF351 096-331	19 mm nízky tlak	Hliník
	8FF351 096-071	16 / 13 mm		Hliník			
	8FF351 096-351	16 / 15 mm	Hliník				
	8FF351 096-371	19 / 16 mm	Hliník				

Tabuľka iných častí spojov							
Popis a obrázok	Index tovaru	Rozmery	Materiál	Popis a obrázok	Index tovaru	Rozmery	Materiál
oring vonkajší, bez matky, na ventily príruby 	8FF351 058-001	nr 10 nr 12	Hliník	kužeľ samček --> MPT rovná 	8FF351 042-201	1/4" --> 1/8"	
svorková tulejka na hrubostenné vedenia 	8FF351 045-021	nr.6	oceľ	samček --> kužeľ samček rovná 	8FF351 042-191	3/16" --> 1/4"	
	4S 16818	nr.8	oceľ				
	8FF351 045-001	nr.10	oceľ	o-ring --> kužeľ rovné 	8FF351 042-161	nr.6	Hliník
	4S 16822	nr.12	oceľ		8FF351 042-121	nr.8	Hliník
svorková tulejka na tenkostenné vedenia 	8FF351 045-801	nr.6	oceľ	8FF351 042-181	nr.10	Hliník	
	8FF351 045-811	nr.8	oceľ	8FF351 042-141	nr.12	Hliník	
	8FF351 045-821	nr.10	oceľ	York 	4S 12708	1/2" samček kužeľ	
	8FF351 045-831	nr.12	oceľ		4S 12710	5/8" samček kužeľ	
spojky beadlock na zváranie 	8FF351 087-041	nr.6	oceľ	York 	4S 12718	1/2" samček o-ring	
	4S 14261		Hliník		4S 12720	5/8" samček o-ring	
	8FF351 087-051	nr.8	oceľ		4S 12728	1/2" samček o-ring	
	4S 14262		Hliník		4S 12730	5/8" samček o-ring	
	8FF351 087-061	nr.10	oceľ				
	4S 14263		Hliník				
8FF351 087-071	nr.12	oceľ					
4S 14264		Hliník					

Náradie na demontáž spojok typu **Spring Lock**
Ford / Volvo / Hyundai

Index: 4S 59650



MOC: 11,2 €
Cena s DPH: 13,4 €



Index: DOR800-600

Sada na opravu tvrdých vedení systémov klimatizácie firmy DORMAN

Pomocou tejto sady možno vykonávať opravy hliníkových rúrok metódou „za studena“. Zverák malých rozmerov umožňuje vykonanie opravy bez nutnosti demontáže vedenia z vozidla. Montážne diely sú dostupné podľa tabuľky nižšie:

Index	Popis	Obrázok
DOR800-631	hliníkové vedenie $\phi 8$ mmx305mm (8 ks v balení)	
DOR800-632	hliníkové vedenie $\phi 10$ mmx305mm (6 ks v balení)	
DOR800-633	hliníkové vedenie $\phi 12$ mmx305mm (4 ks v balení)	
DOR800-634	hliníkové vedenie $\phi 16$ mmx305mm (6 ks v balení)	
DOR800-635	hliníkové vedenie $\phi 19$ mmx305mm (4 ks v balení)	
DOR800-651	elastické vedenie 380mm z koříc. alu $\phi 8$ mm 2 ks v balení	
DOR800-652	elastické vedenie 380mm z koříc. alu $\phi 10$ mm 2 ks v balení	
DOR800-653	elastické vedenie 380mm z koříc. alu $\phi 12$ mm 2 ks v balení	
DOR800-649	tesniaca kvapalina 1 ks v balení	
DOR800-660	ručný lis pre hliníkové rúry (zam. Ind.)	
DOR800-661	jarmo $\phi 8$ mm 2 ks v sade (zam. ind.)	
DOR800-662	jarmo $\phi 10$ mm 2 ks v sade (zam. ind.)	
DOR800-663	jarmo $\phi 12$ mm 2 ks v sade (zam. ind.)	
DOR800-664	jarmo $\phi 16$ mm 2 ks v sade (zam. ind.)	
DOR800-665	jarmo $\phi 19$ mm 2 ks v sade (zam. ind.)	
DOR800-669	nůž s valčekmi (zam. ind.)	
DOR800-681	spojka $\phi 8$ mm 8 ks v balení	
DOR800-682	spojka $\phi 10$ mm 8 ks v balení	
DOR800-683	spojka $\phi 12$ mm 4 ks v balení	
DOR800-684	spojka $\phi 16$ mm 4 ks v balení	
DOR800-685	spojka $\phi 19$ mm 3 ks v balení	
DOR800-691	spojka uhlová $\phi 8$ mm 4 ks v balení	
DOR800-692	spojka uhlová $\phi 10$ mm 4 ks v balení	
DOR800-693	spojka uhlová $\phi 12$ mm 4 ks v balení	
DOR800-694	spojka uhlová $\phi 16$ mm 2 ks v balení	
DOR800-695	spojka uhlová $\phi 19$ mm 2 ks v balení	
DOR800-942	spojka $\phi 12$ mm s servisným ventilom nízkeho tlaku 1 ks v balení	
DOR800-943	spojka $\phi 16$ mm s servisným ventilom vysokého tlaku 1 ks v balení	
DOR800-951	hrdlo $\phi 10$ mm s konc. samček O-ring vonk. 4 ks v balení	
DOR800-952	hrdlo $\phi 12$ mm s konc. samček O-ring vonk. 4 ks v balení	
DOR800-953	hrdlo $\phi 16$ mm s konc. samček O-ring vonk. 4 ks v balení	
DOR800-954	hrdlo $\phi 19$ mm s konc. samček O-ring vonk. 2 ks v balení	
DOR800-956	hrdlo $\phi 10$ mm s konc. samček O-ring vnút. 4 ks v balení	
DOR800-957	hrdlo $\phi 12$ mm s konc. samček O-ring vnút. 4 ks v balení	
DOR800-958	hrdlo $\phi 16$ mm s konc. samček O-ring vnút. 2 ks v balení	
DOR800-959	hrdlo $\phi 19$ mm s konc. samček O-ring vnút. 2 ks v balení	
DOR800-961	hrdlo $\phi 10$ mms konc. samička - O-ring vonk. 4 ks v balení	
DOR800-962	hrdlo $\phi 12$ mms konc. samička - O-ring vonk. 4 ks v balení	
DOR800-963	hrdlo $\phi 16$ mms konc. samička - O-ring vonk. 2 ks v balení	
DOR800-964	hrdlo $\phi 19$ mms konc. samička - O-ring vonk. 2 ks v balení	
DOR800-986	spojka $\phi 10$ mm s servisným ventilom vysokého tlaku 1 ks v balení	
DOR800-987	spojka $\phi 12$ mm s servisným ventilom vysokého tlaku 1 ks v balení	
DOR800-990	spojka uhlová $\phi 12$ mm s konc. samček O-ring vnútorný. 2 ks v balení	
DOR800-991	spojka $\phi 12$ mm s konc. samček O-ring vnútorný. 2 ks v balení	

O-krúžkov a tesnenia klimatizácie

Ponuka o-krúžkov a tesnení používaných v rôznych a početných spojoch systému klimatizácie je veľmi široká. V nižších tabuľkách sú uvedené najpoužívanejšie z nich. Ďalšie nájdete v katalogoch výrobcov:

Výrobca	Tlačený katalóg		Elektronický katalóg CD		Katalóg on-line	Tec Doc	Príklad indexu tovaru
	Vydanie	Index IC	Vydanie	Index IC			
	2009/2010	002491 011	2008/2009	002491 009	www.hella.sk	✓	9GR351 254-861
	2010	002518 027	2010	002518 028	—	✓	TSP0695017
	2009/2010	279514 001	—	—	http://www.4s-europe.com	—	4S 24608

DELPHI - Tabuľka najpoužívanejších o-krúžkov dostupných po 1 ks.











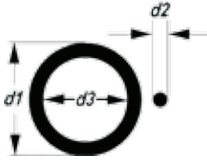
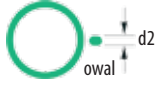
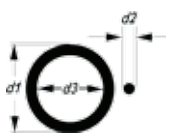



O-krúžok	Rozmery d1 x d2 (vonkajší priemer x hrúbka)	Index
	6,65 x 1,5	069579/0
	7,66 x 1,78	069505/0A
	10,82 x 1,78	069506/0A
	14 x 1,78	069507/0A
	16 x 2,65	069630/0
	17,16 x 1,78	069508/0A
	19 x 2,65	0698008

Sada Hella - 9GR351 254-861



















Sada 9GR351 254-861 zahŕňa:	Počet o-ringov/častí v sade	Materiál	Farba	Rozmer	Rozmery: priem. vnút. x vonk. x hrúbka [mm]	Počet v doplnkovej sade [ks]	Index doplnkovej sady	
	Štandardné o-ringy	10 ks	HNBR	zelený	nr 4. 1/4"	6,07x9,33x1,63mm	20 ks	9GR351 280-901
		10 ks	HNBR	zelený	nr 6. 3/8"	7,65x11,21x1,78mm	20 ks	9GR351 288-861
		10 ks	HNBR	zelený	nr 8. 1/2"	10,82x14,38x1,78mm	20 ks	9GR351 288-871
		10 ks	HNBR	zelený	nr 10. 5/8"	14x17,56x1,78mm	20 ks	9GR351 288-881
		10 ks	HNBR	zelený	nr 12. 3/4"	17,17x20,73x1,78mm	20 ks	9GR351 288-891
		5 ks	Neoprén	čierny	nr.:6 ; 3/8"	6,02x11,26x2,62mm	20 ks	9GR351 289-841
		5 ks	HNBR	zelený	9,19 mm PAD	9,19x14,43x2,62mm	20 ks	9GR351 280-961
		5 ks	HNBR	zelený	nr.:10 ; 5/8"	12,37x17,61x2,62mm	20 ks	9GR351 288-951
		5 ks	HNBR	zelený	nr.:12 ; 3/4"	13,94x19,18x2,62mm	20 ks	9GR351 288-961
		5 ks	HNBR	zelený	9,25mm	9,25x12,81x1,78mm	20 ks	9GR351 283-821
		6 ks	HNBR	zelený	17,12mm	17,12x22,36x2,62mm	20 ks	9GR351 289-811
		6 ks	HNBR	zelený	20,22mm	20,22x27,28x3,53mm	20 ks	9GR351 287-961
		5 ks	HNBR	zelený	21,89mm	21,89x27,13x2,62mm	20 ks	9GR351 287-971
		5 ks	HNBR		10,77mm	10,77x16,01x2,62mm	20 ks	9GR351 288-801
		4 ks	Kov-Neoprén	čierny	GM, Delphi, Harrison	5/8" ; 15,5x27,9mm	6 ks	9GR351 288-811
	4 ks	Kov	čierny	GM, Delphi, Harrison	3/4" ; 17,5x31,5mm	6 ks	9GR351 288-821	
	4 ks	Kov	čierny	GM, Delphi, Harrison	5/8" ; 15,5x27,9mm	6 ks	9GR351 288-831	
O-ringi obdĺžnikový priemer	5 ks	teflón	biely		15,87x19,05x1,57mm	20 ks	9GR351 288-991	
	5 ks	Neoprén	čierny		19,68x23,75x2,03mm	20 ks	9GR351 283-841	
O-ringi do spring lock	6 ks	HNBR	zelený	nr 6. 3/8"	7,38x11x1,81mm	20 ks	9GR351 282-901	
	6 ks	HNBR	zelený	nr 8. 1/2"	10,12x13,82x1,85mm	20 ks	9GR351 282-911	
	6 ks	HNBR	zelený	nr 10. 5/8"	12,93x16,63x1,85mm	20 ks	9GR351 282-851	
	6 ks	HNBR	zelený	nr 12. 3/4"	15,68x19,54x1,93mm	20 ks	9GR351 282-891	

Tovar	Materiál	Rozmer	Počet ks v sade	Index
	oceľ pružinová	nr 6. 3/8"	6 ks	9GR351 287-941
	oceľ pružinová	nr 8. 1/2"	6 ks	9GR351 287-951
	oceľ pružinová	nr 10. 5/8"	6 ks	9GR351 287-931
	oceľ pružinová	nr 12. 3/4"	6 ks	9GR351 282-871

Hella - Tabuľka o-kružkov a tesnení

Tovar v ponuke IC	Materiál	Farba	Rozmer	Rozmery d3 x d1 x d2 priem. vnút. x vonk. x hrúbka [mm]	Počet ks v sade	Index
O-ringi okrúhle						
	HNBR	zelený	POA; VIR	4,7x7,54x1,42 mm	20 ks	9GR351 281-841
	HNBR	zelený	6,6 mm	6,6x10,6x2,0 mm	20 ks	9GR351 282-931
	HNBR	zelený	7mm	6,8x10,54x1,87 mm	20 ks	9GR351 280-881
	HNBR	zelený		7,65x10,91x1,63 mm	20 ks	9GR351 282-941
	HNBR	zelený		8x12x2 mm	20 ks	9GR351 280-911
	HNBR	zelený	9mm	9x13,78x2,39 mm	20 ks	9GR351 280-941
	HNBR	zelený	10mm	10x15x2,5 mm	20 ks	9GR351 280-801
	HNBR	zelený		15,54x20,78x2,62 mm	20 ks	9GR351 288-971
	HNBR	zelený	17mm	17x21x2 mm	20 ks	9GR351 280-861
	HNBR	zelený		18,72x23,96x2,62 mm	20 ks	9GR351 280-871
	HNBR	zelený		20,29x25,53x2,62 mm	20 ks	9GR351 289-801
	Neoprén	čierny	6,73mm	6,73x10,73x2 mm	20 ks	9GR351 280-891
	Neoprén	čierny	8,92mm	8,92x12,58x1,83 mm	20 ks	9GR351 280-921
	Neoprén	čierny	16mm	16x19,56x1,78 mm	20 ks	9GR351 280-841
Neoprén	zelený		23,47x28,71x2,62 mm	20 ks	9GR351 281-801	
O-ringi oválne						
	HNBR	zelený	Denso, Ford Visteon	18,9x30,05x3,66 mm	20 ks	9GR351 288-841
	HNBR	zelený	GM HR6	23,05x23,05x3,5 mm	20 ks	9GR351 282-951
O-ringi metrické						
	HNBR	zelený	6mm, metrický	6,07x9,33x1,63 mm	20 ks	9GR351 285-981
	HNBR	zelený	7mm, metrický	7,5x11,5x2 mm	20 ks	9GR351 281-951
	HNBR	zelený	10mm, metrický	10,5x14,5x2 mm	20 ks	9GR351 281-931
	HNBR	zelený	10mm, metrický	10,8x14,8x2 mm	20 ks	9GR351 281-961
	HNBR	zelený	14mm, metrický	14,3x18,9x2,3 mm	20 ks	9GR351 282-841
	HNBR	zelený	16mm, metrický	16,5x21,36x2,43 mm	20 ks	9GR351 281-981
	Neoprén	čierny	20mm, metrický	20,35x23,91x1,78 mm	20 ks	9GR351 283-831
Kovové tesnenia						
	Kov-Neoprén	čierny	Chrysler, Sanden	priemer vnútorný 16mm RV/RV2	6 ks	9GR351 253-891
	Kov-Neoprén	čierny	Chrysler, Denso	priemer vnútorný 19mm RV/RV2	6 ks	9GR351 253-861
	Kov-Neoprén	čierny	Chrysler, Sanden	RV/RV2	6 ks	9GR351 253-871
	Kov-Neoprén	čierny	Denso	C171; A590	6 ks	9GR351 286-971
	Kov	čierny			6 ks	9GR351 286-941
	Kov-Neoprén	čierny			6 ks	9GR351 253-881
	Kov	čierny			6 ks	9GR351 286-931
	Kov	čierny			6 ks	9GR351 286-951
	Aluminium		GM, Delphi, Harrison	HD-6; HT-6; R4; V5; V7	6 ks	9GR351 281-891
Tesnenia						
		čierny	10PA15, 10PA17, 10PA20		1 ks	9GR351 253-011
		čierny	mercedes		6 ks	9GR351 282-801
		čierny	10PA Použitie mercedes		6 ks	9GR351 282-811
		čierny	10PA15, 10PA17, 10PA20		6 ks	9GR351 282-831
		čierny	75BU		6 ks	9GR351 289-931

O-krúžky a tesnenia klimatizácie - sady

Index/Cena	Popis	Obrázok	Index/Cena	Popis	Obrázok
TSP0695021 MOC: 38,1 € s DPH: 45,7 €	Skrinka na tesnenia O-Ring (4 kazety)		9GR351 276-821 MOC: 53 € s DPH: 63,6 €	Sada montážna Ford	
9GR351 254-921 MOC: 131 € s DPH: 157,2 €	Sada 32 ks univerzálna		9GR351 276-831 MOC: 57,3 € s DPH: 68,8 €	Sada montážna Ford	
4S 24640 MOC: 26,1 € s DPH: 31,3 €	Sada 12 ks univerzálna Sada o-ringov		TSP0695023 MOC: 62,3 € s DPH: 74,8 €	Sada montážna Ford	
9GR351 275-881 MOC: 76 € s DPH: 91,2 €	Sada montážna Alfa Romeo		TSP0695008 MOC: 56,8 € s DPH: 68,2 €	Sada montážna Mercedes	
9GR351 275-891 MOC: 94,7 € s DPH: 113,6 €	Sada montážna Audi/VW		9GR351 275-851 MOC: 106 € s DPH: 127,2 €	Sada montážna Opel	
TSP0695002 MOC: 81,3 € s DPH: 97,6 €	Sada montážna Audi/VW		TSP0695009 MOC: 53,4 € s DPH: 64,1 €	Sada montážna Opel	
9GR351 276-801 MOC: 44,1 € s DPH: 52,9 €	Sada montážna BMW		VAL509203 MOC: 68 € s DPH: 81,6 €	Sada montážna Peugeot	
TSP0695007 MOC: 64,9 € s DPH: 77,9 €	Sada montážna Fiat		9GR351 275-821 MOC: 62,3 € s DPH: 74,8 €	Sada montážna Renault	
TSP0695020 MOC: 108 € s DPH: 129,6 €	Sada montážna Fiat, Peugeot, Renault, Citroen		TSP0695016 MOC: 88,1 € s DPH: 105,7 €	Sada montážna - európske vozy	

Servisné ventily



4Seasons	Hella	Valeo	Delphi	Technický popis	Obrázok
4S 59334	8UW351 285-901	VAL509218	0695172/0	Ventilček klimatizácie M5	
4S 59335	8UW351 282-991	VAL509217	0695185/0	Ventilček klimatizácie M8	
4S 59345	8UW351 281-921		0695174/0	Ventilček klimatizácie GM s vysokým prietokom R12 & R134a	
4S 59346	8UW351 283-811	VAL509215	0695204/0	Ventilček klimatizácie Eaton 13mm s vysokým prietokom R134a	
4S 59347	8UW351 282-971	VAL509216	0695173/0	Ventilček klimatizácie JRA M6	
4S 59355	8UW351 286-911		0695205/0	Servisný ventilček Eaton M8 R134a	
4S 59356	8UW351 286-921		0695206/0	Ventilček klimatizácie Eaton M10	
4S 59945			0695290/0	Servisný ventil R134a nízky tlak	
4S 59946	8UW351 248-051		0695289/0	Servisný ventil 16mm M12x1.5	
4S 59972	8UW351 089-001		0695287/0	Servisný ventil 15mm, M15 x 1.0	
4S 59973	8UW351 089-011		0695288/0	Servisný ventil 13mm, M13 x 1.0	
4S 59976	9XD351 201-031			Retrofit adaptér 1/4" - nízky tlak	
4S 59977	9XD351 201-011			Retrofit adaptér 1/4" - vysoký tlak	

Sady servisných ventilčekov



Sada servisných ventilčekov



Index: 8UW351 248-871

MOC: 86,8 €

Cena s DPH: 104,2 €



Sada servisných ventilčekov - 47ks



Index: VAL509735

MOC: 85,6 €

Cena s DPH: 102,7 €



Sada servisných ventilčekov



Index: TSP0695015

MOC: 72,2 €

Cena s DPH: 86,6 €

Chémia, oleje PAG

CARTECHNIC – Oleje do klimatizácie

PAG-OIL 46 AA1, 250ml

Index: CART00301

PAG-OIL 100 AA1, 250ml

Index: CART00302

PAG-OIL 150 AA1, 250ml

Index: CART00303

MOC: 10,2 €

Cena s DPH: 12,2 €



LIQUI MOLY

Syntetický olej do zariadenia klimatizácie na báze polyglykogénu. Vhodný pre mazanie, tesnenie a chladenie pohyblivých častí v systéme chladenia.

Rozlišujeme tri druhy olejov pre klimatizáciu: PAG 46, PAG 100 a PAG150. 250ML

Index IC: LIM4083, LIM4089, LIM4082

MOC LIM4083, LIM4082, LIM4089: 17,53 €

Cena s DPH LIM4083, LIM4082, LIM4089: 21 €



PROFITOOL

Sada pre dávkovanie farbiva; dávkovač farbiva s rýchlopínacím vedením do chladiva R134a, farbivo 4x30ml



Index IC: 0XPTKB0004

MOC: 253 €

Cena s DPH: 303,6 €



PROFITOOL

Sada farbív; cartridge do dávkovača farbiva; 4 ks, objem: 30ml (5 dávok farbiva v jednom obale)



Index IC: 0XPTKM0001

MOC: 66,9 €

Cena s DPH: 80,28 €

Magneti Marelli

Farbivo UV
Objem: 240ml



Index IC: 007935090640

MOC: 50,8 €

Cena s DPH: 60,96 €



DELPHI

Farbivo 32 dávok
s mierkou, 240ml



Index: PLHAT41555

MOC: 29 €

Cena s DPH: 34,8 €



PROFITOOL

Čistič farbiva UV
objem: 960ml



Index IC: 0XPTKM0004

MOC: 24,6 €

Cena s DPH: 29,5 €



HELLA

Prostriedok na čistenie farbiva UV
objem: 500ml



Index IC: 8PE351 225-141

MOC: 23,6 €

Cena s DPH: 28,3 €



DELPHI

Olej do vákuovej pumpy klimatizácie.



Index IC: PLH041197/0

MOC: 17,2 €

Cena s DPH: 20,6 €



Texa

Olej do vákuovej pumpy klimatizácie.



Index IC: TEX 3900820

MOC: 54,6 €

Cena s DPH: 65,5 €



FUCHS

Olej do klimatizácie vozidla, SEZ80 1L

Index IC: FUCHS/SEZ80

MOC: 49,36 €

Cena s DPH: 59,2 €

Olej do klimatizácie v autobusocho, SEZ55 1L

Index IC: FUCHS/SEZ55

MOC: 30,1 €

Cena s DPH: 36,12 €



DELPHI

Prostriedok na preplachovanie systému klimatizácie 5L (napr. pre plničky s preplachovacou sadou ako SPIN, alebo zariadenie na preplachovanie: PLHAT41415)



Index IC: PLHAT41425

MOC: 53 €

Cena s DPH: 63,6 €



Chémia, oleje PAG

CRC AIRCO KLEEN

Prostriedok na čistenie klimatizácie. Jeho použitie si nevyžaduje demontáž častí systému klimatizácie, je používaný v kabine vozidla. Obsahuje silnú bakteriálo-fungicídnu zložku. Balenie 200ML

Index IC: CRC10214109

MOC: 9,36 €

Cena s DPH: 11,23 €



COMMA AIR CON CLEANER

Prostriedok na čistenie všetkých systémov klimatizácie.. Rýchlo odstraňuje akékoľvek baktérie, plesne, vírusy zo systémov klimatizácie vozidiel, ktoré sú príčinou nepríjemného zápachu, ako aj iných alergických reakcií. Dodatočne odstraňuje nepríjemný zápach z koberčekov a podlahových obložení v kabine. Zanecháva sviežu vôňu. Jednoduchý na použitie. Jednorazové balenie zabezpečuje dokonalé a účinné odplesnenie klimatizácie behom 10 minút! Balenie 150ML.

Index IC: AIR CON CLEANER 150ML

MOC: 9,6 €, Cena s DPH: 11,52 €



LOCTITE HYGIENE SPRAY

viacúčelový čistiaci prostriedok pre odstránenie plesní a čistenie systémov klimatizácie automobilov. Ničí baktérie, plesne, vírusy a nepríjemné zápachy premieňa na sviežu mentolovo-eukaliptovú vôňu. Sprej môže vyčistiť do 50m³ vzduchu. Balenie 150ML

Index IC: LOC 40387 150ML SPRAY

MOC: 19,39 €

Cena s DPH: 23,3 €



LIQUI MOLY - Klima Fresh

prostriedok na čistenie a zbavenie sa plesne systému klimatizácie. Objem 150ML

Index IC: LIM4065

MOC: 18 € Cena s DPH: 21,6 €



AMTRA - NanoSilver

Prostriedok na čistenie klimatizácie, umožňuje efektívne čistenie systému klimatizácie vo vozidle. Ničí baktérie, plesne a osviežuje, ako aj zabezpečuje pred nepríjemným zápachom na dobu od 3 do 5 mesiacov. Objem 200ML

Index IC: NANO 19-535 200ML

MOC: 12,75 €

Cena s DPH: 15,3 €



LIQUI MOLY

Špeciálny tekutý čistič, ktorý optimálnym spôsobom, šetrne a bez demontáže čistí výparník klimatizácie od plesní a baktérií. Objem 250ML

Index IC: LIM4087

MOC: 24,8 € Cena s DPH: 29,8 €



VPS VALVOLINE

Profesionálny prostriedok na čistenie a odplesnenie klimatizácie. Zabíja a odstraňuje plesne a baktérie.

Objem balenia stačí na 3 vozidlá!

Balenie 500ML

Index IC: VPS AIRCO ODOR TREATMENT

MOC: 9,6 €

Cena s DPH: 11,52 €



PARYS - ATAS

Prostriedok pre osvieženie klimatizácie. Prostriedok zabezpečí dokonalú hygienu vo vnútri vozidla, ako aj eliminuje nepríjemný zápach, ktorý je výsledkom dlhodobej prítomnosti baktérií, ako aj rôzneho druhu hmyzu. Objem prostriedku stačí na 3-4 násobné použitie. Objem 400ML

Index IC: CLIM 400ML

MOC: 5,81 €

Cena s DPH: 6,97 €



CARTECHNIC

Sprej na odhalenie výtekov plynov. Umožňuje nájdenie netesností jednoduchým, ekonomickým a bezpečným spôsobom. Špeciálna konštrukcia ventilu umožňuje jeho použitie v ťažko dostupných miestach. Balenie 400ML

Index IC: CART00213

MOC: 3,85 €

Cena s DPH: 4,62 €



CRC AIRCO CLEANER

Pena na čistenie systému klimatizácie vozidla. Odstraňuje dráždivý zápach vytváraný znečistením výparníka v systéme klimatizácie. Vytvára sviežu vôňu. Objem 400ML

Index IC: CRC10702113

MOC: 8,33 €

Cena s DPH: 10 €



LOCTITE TEROSEPT 5L

kvapalina pre odstránenie plesne z klimatizácie

Index IC:

LOC 14558Z TEROSEPT 5L

MOC: 147,25 € Cena s DPH: 176,7 €



Liqui Moly Klimaanlage-Reiniger

tekutina pre odstránenie plesne /pre zariadenie LIM4090/ – špeciálny penový čistič, ktorý optimálnym spôsobom, šetrne a bez demontáže čistí klimatizér od plesní a baktérií. Vlastnosti: odstraňuje nepríjemný zápach, ničí plesne a baktérie, veľmi účinný, dlhotrvajúci efekt vďaka povlaku, ktorý vzniká vo výparníku a zabraňuje tvoreniu nových plesní. Balenie 5L.

Index IC: LIM4092

MOC: 95,47 €

Cena s DPH: 114,6 €



LIQUI MOLY Sada pre klimatizáciu

skladá sa z profesionálneho zariadenia pre prácu s klimatizáciou a dvoch bandasiiek s 5L kvapaliny pre odplesnenie klimatizácie – je to špeciálny penový čistič ktorý optimálnym spôsobom, šetrne a bez demontáže čistí klimatizáciu od plesní a baktérií. Vlastnosti: odstraňuje nepríjemný zápach, ničí baktérie, veľmi výdatný, dlhotrvajúci efekt vďaka povlaku, ktorý zostáva vo výparníku a zabraňuje tvoreniu nových plesní.

Index IC: LIM4090 PROMOCJA

MOC: 379 €

Cena s DPH: 455 €



AKCIA

diely klimatizácie

inter cars 
automobilové diely

400,- € bez DPH	800,- € bez DPH	1200,- € bez DPH	1600,- € bez DPH
Thule 530 	Thule 591 	Thule 9708 	Thule 9105 
UV led lampa + okuliare BSL845 	Infračervený teplomer SPIN 04.017.00 	Laserový teplomer SEA Vs905 	Sada na kontrolu netesností OXPTKB0001 
5x 	11x 	17x 	24x 

Nakupujte v období od **1.apríla do 31.mája** diely klimatizácie, chladiče, vodné čerpadlá, diely kúrenia, ventilátory, snímače, montážne sady, dolu uvedených značiek v hodnotách **400€, 800€, 1200€, alebo 1600€** bez DPH a získajte darčeky na základe tabuľky z tohto letáku. Podľa Vášho obratu si môžete vybrať z ponuky darčiekov, v ktorej sú **nosiče bicyklov Thule, dielenské vybavenie, alebo čističe klimatizácií.**

Airstal
AUTORIZOVANÝ PARTNER

BEHR
SERVICE

HELLA

TEAMEC

4 SEASONS
Special Automotive Parts

MAGNETI MARELLI

Valeo

DELPHI

Nissens

DENSO

VEMO
Leading brand in automotive systems

FRIGAIR

THERMOTEC

www.intercars.sk

JARNÁ PONUKA VYBAVENIA DIELNÍ

Ku každej zakúpenej plničke klimatizácie získavate okrem zľavy aj zdarma ŠTARTOVACÍ BALÍČEK v hodnote 284€ s DPH!

Štartovací balíček obsahuje: Olej do systému klimatizácie, 1L, UV farbivo, 350ml nádoba, tester systému A/C s núdzovým plnením, sadu 120ks O-ringov, digitálny teplomer so sondou, čistiaca antibakteriálna sada

+ ZADARMO
ŠTARTOVACÍ
BALÍČEK

1 Automatická plnička SPIN CLEVER 134 PRINTER

SPIN 01.018.01

Manuálne nastavenie množstva oleja a farbiva, automatizované odsávanie, separácia oleja, programovateľné vákuum, test vákua, prídanie oleja, plnenie chladivom. Možnosť dokúpiť databázu pre autá, ťahače, poľnohospodárske stroje, Vlastnú databázu, verziu Bigas (R12-R134a). Na špeciálnu objednávku možnosť viacerých farebných vyhotovení. Integrovaná databáza s vozidlami, ako aj možnosť vlastnej databázy. Hadice L=3mt v súlade s SAEJ2196. Možnosť dokúpiť výhrevný pás.

+ ZADARMO
ŠTARTOVACÍ
BALÍČEK

SPIN srl



2 Automatická plnička SPIN BREEZE EVOLUTION 134 PRINTER

SPIN 01.001.09

Plná automatika pre osobné, nákladné vozidlá a minibusy s R134. Automatizované odsávanie, separácia oleja, programovateľné vákuum, test vákua, prídanie oleja, plnenie chladivom. Čas, dátum, možnosť užívateľského hesla, štatistika použitia chladiva. Tlačiareň v dodávke (24 stĺpcová). Hadica L=3mt s R134 spojkami a ventilmi. Dodaná databáza s viac ako 1000 údajmi, vlastná databáza s 30 údajmi. 20x4 digitálny LCD displej, výhrevný pás.

+ ZADARMO
ŠTARTOVACÍ
BALÍČEK

SPIN srl



3 Automatická plnička SPIN BREEZE EVOLUTION BUS 134

SPIN 01.001.12

Plná automatika pre autobusy, osobné aj nákladné vozidlá. Automatizované odsávanie, separácia oleja, programovateľné vákuum, test vákua, prídanie oleja, plnenie chladivom. Čas, dátum, možnosť užívateľského hesla, štatistika použitia chladiva. Možnosť dokúpiť tlačiareň (24 stĺpcov). Hadica L=3mt s R134 spojkami a ventilmi. 2 pevné kolieska, 2 kolieska s brzdou. Nádoba s automatickým ohrevom. 20x4 digitálny displej. Integrovaná databáza s vozidlami, ako aj možnosť vlastnej databázy. Výhrevný pás. Možnosť dokúpiť tlačiareň.

+ ZADARMO
ŠTARTOVACÍ
BALÍČEK

SPIN srl



Technické údaje

	CLEVER 134 PRINTER	BREEZE EVOLUTION 134 PRINTER	BREEZE EVOLUTION BUS 134
Chladivo	R134A	R134A	R134A
Použitie	osobné/nákladné	osobné/nákladné	osobné/nákladné/autobusy
Spôsob práce	manuálny/automatický	manuálny/automatický	manuálny/automatický
Prídavanie oleja a UV farbiva	manuálne/automatický	manuálne/automatický	manuálne/automatický
Databáza automobilov	áno	áno, možnosť aktualizácie cez USB	áno, možnosť aktualizácie cez USB
Ovládanie otv./zatv. vedení HP/LP	automatické	automatické	automatické
ventily ø80mm tr. 1 so škálou	áno	áno	áno
Objem nádoby R134A	12,5 kg	22 kg	30 kg
Vákuová pumpa	70 L/min	142 L/min	142 L/min
automatický preplachovací SW	nie	áno	áno
SW v 17 jazykoch, vrátane českého	áno	áno	áno
Možnosť dokúpiť prídavný hardvér	nie	áno	áno
Tlačiareň	áno	voliteľné (Index IC:SPIN 01.000.24)	áno
Kompresor	400 g/1l	400 g/1l	600 g/1l
Rozmery	500x520x950mm	550x500x1310mm	550x500x1310mm
Váha	65Kg	90Kg	110Kg

4 Automatická plnička EVERT BASIC PRINTER

EVERTACBASIC

Manuálne alebo automatické nastavenie množstva oleja a farbiva, automatizované odsávanie, separácia oleja, programovateľné vákuum, test vákua, pridanie oleja, plnenie chladivom. Možnosť dokúpiť databázu pre autá, ťahače, poľnohospodárske stroje. Integrovaná databáza s vozidlami, ako aj možnosť vlastnej databázy. Hadice o dĺžke 3 metre, v súlade s SAEJ2196. Automatické ohrievanie. Vybavená SW pre efektívnu prácu s chladivom, pre rôzne systémy čistenia a môžete ju dovybaviť špeciálnym príslušenstvom pre prácu na hybridoch a plnenie oleja a UV pod vákuom.



5 Automatická plnička EVERT CLIMA PRINTER+

EVERTACPLUS

Plná automatika pre osobné, nákladné vozidlá a minibusy s R134. Automatizované odsávanie, separácia oleja, programovateľné vákuum, test vákua, pridanie oleja, plnenie chladivom. Čas, dátum, možnosť užívateľského hesla, štatistika použitia chladiwa. Tlačiareň v dodávke. Hadica o dĺžke 3 metre s R134 spojkami a ventilmi. Nádoby na starý, nový olej a aditíva. Dodaná databáza s viac ako 1000 údajmi, vlastná databáza s 30 údajmi., LCD displej, automatický výhrevný pás. Vybavená SW pre efektívnu prácu s chladivom, pre rôzne systémy čistenia a môžete ju dovybaviť špeciálnym príslušenstvom pre prácu na hybridoch a plnenie oleja a UV pod vákuom.



6 Automatická plnička BOSCH ACS 650

F 002 DG2 400

Plná automatika pre autobusy, osobné aj nákladné vozidlá. Automatizované odsávanie, separácia oleja, programovateľné vákuum, test vákua, pridanie oleja, plnenie chladivom. Funkcia preplachovania. Možnosť prepnutia do manuálneho módu. Robustná a ergonomická konštrukcia vozíka. LED indikátor, akustická signalizácia, 3,5" farebný displej. Rozsiahla databáza predpísaných hodnôt vozidiel. Rýchly štart. V dodávke tlačiareň, pridávaný manometer pre kontrolu tlaku v zásobníku, zobrazenie servisných prác, jednoduché, intuitívne ovládanie.



BOSCH
Stvorené pre život



Technické údaje

	EVERT BASIC PRINTER	EVERT CLIMA PRINTER+	BOSCH ACS 650
Chladiivo	R134A	R134A	R134A
Použitie	osobné/nákladné	osobné/nákladné	osobné/nákladné/autobusy
Spôsob práce	manuálny/automatický	manuálny/automatický	manuálny/automatický
Pridávanie oleja a UV farbiva	manuálny/automatický	manuálny/automatický	manuálny/automatický
Databáza automobilov	áno	áno, možnosť aktualizácie cez USB	áno
Ovládanie otv./zatv. vedení HP/LP	automatické	automatické	automatické
Prídavné nádoby	2	3	3
Objem nádoby R134A	12,5 kg	18 kg	21,5 kg
Vákuová pumpa	70 L/min	100 L/min	133 L/min
automatický preplachovací SW	áno	áno	áno
SW v medzin. jazykoch, čeština	áno	áno	áno
Kompresor	24kg/h.	24kg/h.	18 kg/h.
Tlačiareň	áno	áno	áno
SW rozširujúci o ďalšie funkcie	áno	áno	nie
Rozmery	500x520x590mm	500x520x590mm	585x1170x730mm
Váha	65Kg	65Kg	110Kg

V ponuke Inter Cars nájdete aj náradie a zariadenia pre servis klimatizácií, chladiivo R134a, farbivá a ďalšie produkty ktoré sa Vám v dielni určite zídu.

PRE INFORMÁCIE A OBJEDNÁVKY O SEZÓNNEJ PONUKE A ŠTARTOVACIOM BALÍČKU KONTAKTUJTE NAŠICH OBCHODNO-TECHNICKÝCH ZÁSTUPCOV:

Západné Slovensko +Žilina	Branislav Mitošinka	0917 424 878
Stredné Slovensko	Peter Chamula	0905 998 720
Východné Slovensko	Ing. Tibor Zentko	0905 656 325
www.vybaveniedieli.sk		



Je čas prejsť na DENSO

Je len jedna vec, chladnejšia
ako naše kompresory klimatizácie



Prečo DENSO kompresory klimatizácie?

- > Svetová 1 vo výrobe originálnych kompresorov klimatizácií
- > Sortiment 100% originálnych kompresorov klimatizácie pre trh s náhradnými dielmi
- > Vysoký výkon navrhnutý tak, aby presne zodpovedal špecifikácii vozidla
- > Balenie obsahuje všetko potrebné pri výmene
- > Vysoká kvalita produktu, veľmi nízka poruchovosť
- > Kompletné zostavy
- > Naplnený správnym množstvom prevádzkovej kvapaliny

Keď príde na originálne autodiely, DENSO je prvou voľbou popredných výrobcov automobilov. Naše inovatívne technológie, systémy a komponenty môžete nájsť v deviatich z desiatich áut na ceste, ktoré sú denne preverované miliónmi vodičov. Pridajte sa k nám dnes, aby ste mohli ťažiť z našich dlhodobých skúseností a kvality originálnych dielov v našom programe náhradných dielov.

Začiatok nášho partnerstva je vzdialený len na jedno kliknutie na www.denso-europe.com



www.denso-europe.com

Driven by
Quality



Inter Cars Bratislava

Ivánska cesta 2
821 04 Bratislava

Tel.: 02/44 630 555

Fax: 02/44 630 777

E-mail: bratislava@intercars.sk



Inter Cars Žilina

Salezánska 2
010 08 Žilina

Tel.: 041/76 33 377

Fax: 041/76 33 378

E-mail: zilina@intercars.sk



Inter Cars Košice

Lubina 1
040 11 Košice

Tel.: 055/72 77 7 11-15

Fax: 055/72 77 710

E-mail: kosice@intercars.sk



Inter Cars Trnava

Bratislavská 45
917 02 Trnava

Tel.: 033/55 33 522

Fax: 033/55 33 272

E-mail: trnava@intercars.sk



Inter Cars Banská Bystrica

Partizánska 89
974 01 Banská Bystrica

Tel.: 048/47 00 888

Fax: 048/47 00 889

E-mail: banska.bystrica@intercars.sk



Inter Cars Prešov

Kúpeľná 8
080 01 Prešov

Tel.: 051/74 85 011-3

Fax: 051/74 85 010

E-mail: presov@intercars.sk



Inter Cars Nitra

Vašinová 70
949 01 Nitra

Tel.: 037/64 10 044

Fax: 037/64 10 045

E-mail: nitra@intercars.sk



Inter Cars Poprad

Partizánska ulica 86/A
058 01 Poprad

Tel.: 052/78 803 51-3

Fax: 052/78 803 50

E-mail: poprad@intercars.sk



Inter Cars Trenčín

Zlatovská 1793
911 05 Trenčín

tel.: 032/32 60 222

fax.: 032/32 60 229

E-mail: trencin@intercars.sk



**Inter Cars Bratislava
Petržalka**

Vyšehradská 2
831 06 Bratislava

Tel: 02 / 32 60 222 5

E-mail: petrzalka@intercars.sk



Inter Cars Ružomberok

Bystrická cesta 5116
034 01 Ružomberok

Tel. : 044/3260222

Fax: 044/3260229

E-mail: ruzomberok@intercars.sk



Inter Cars Humenné

Mierová ulica 62
066 01 Humenné

Tel.: 057/32 60 222

Fax: 057/32 60 229

E-mail: humenne@intercars.sk



Inter Cars Nové Zámky

Ďumbierska 4
940 01 Nové Zámky

Tel.: 035/32 60 222

Fax: 035/32 60 229

E-mail: nove.zamky@intercars.sk

VIP Club
Inter Cars

2011

Kuba

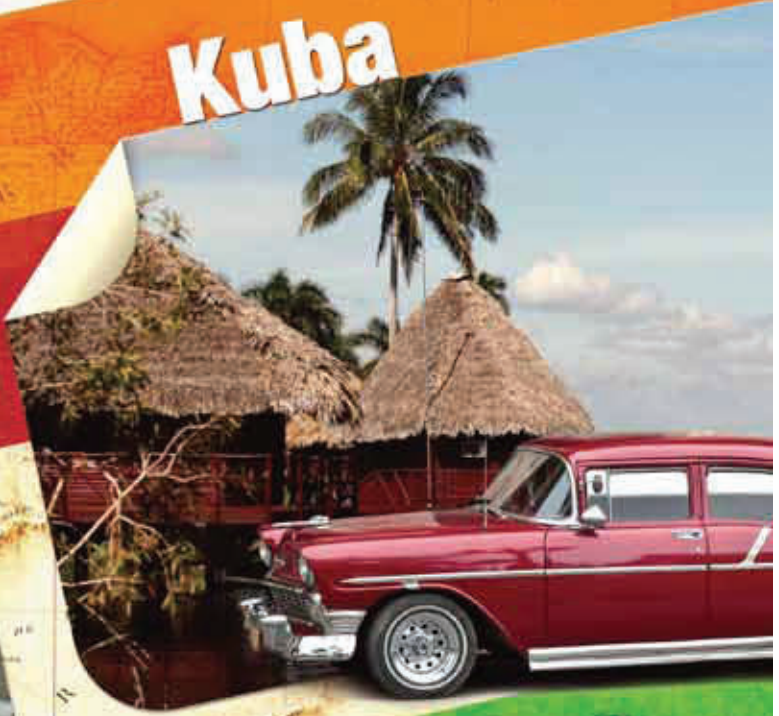

F1 v Európe



Rybačka v **Nórsku**

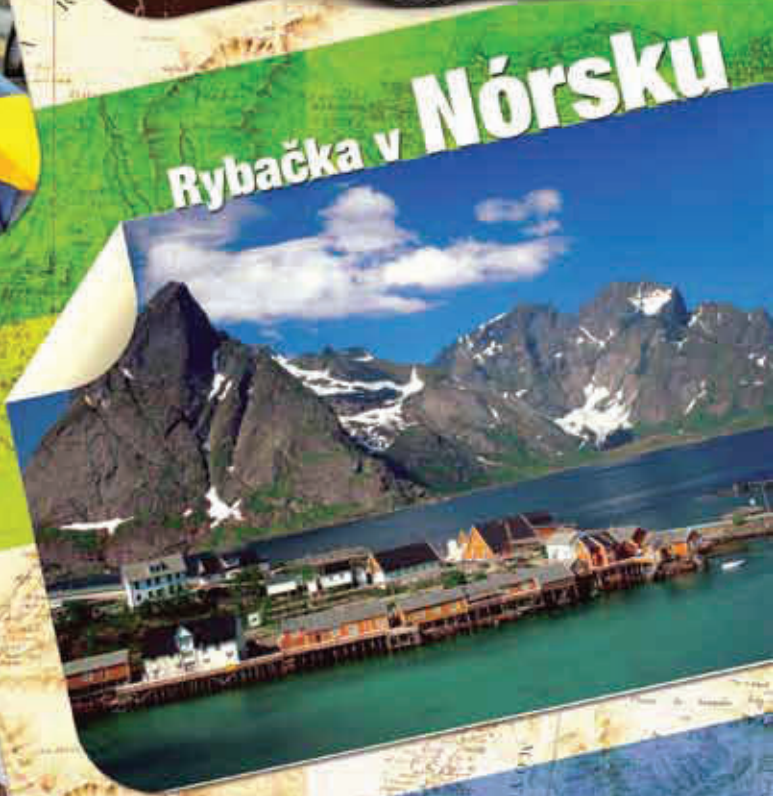

Egypt

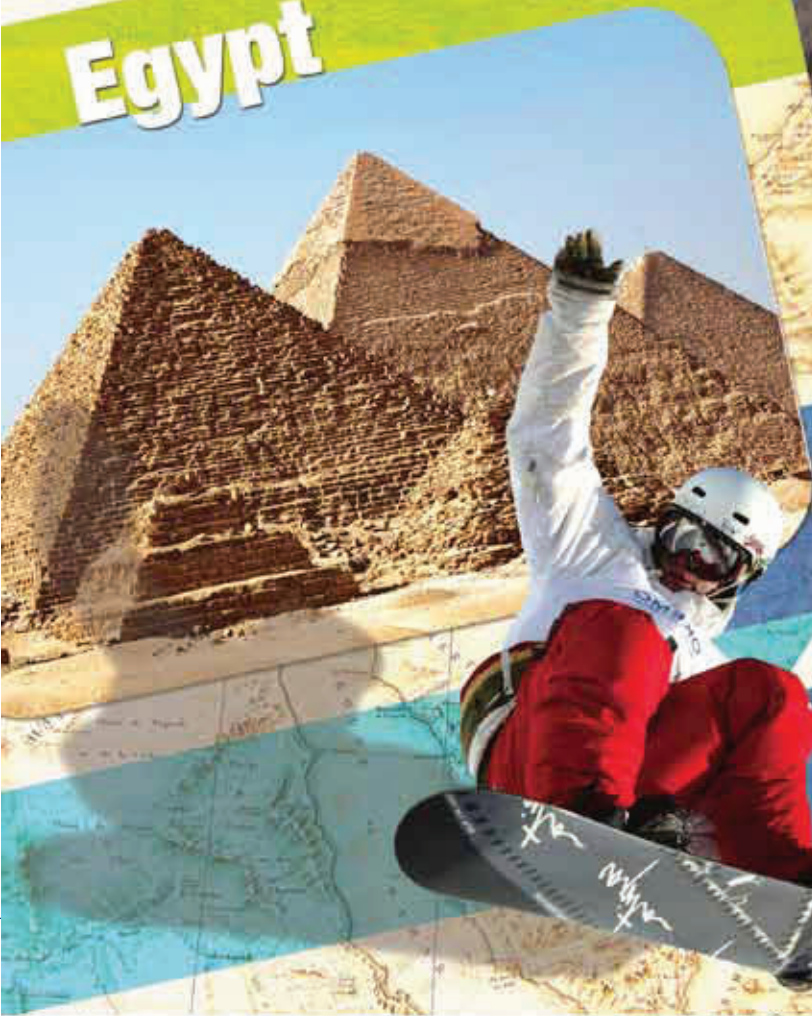

Alpy

